

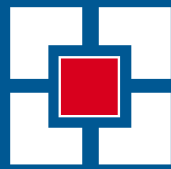

CATÁLOGO GENERAL | 5ª edición



entre **profesionales**



Ferrotech[®]



Ferrotech

DISCO DIAMANTE

GENERAL OBRA
ESTÁNDAR

LA MEJOR ELECCIÓN PARA EL PROFESIONAL

Lorem ipsum dolor sit amet, consectetur adipiscing elit, sed diam nonummy nibh euismod tincidunt ut laoreet dolore magna aliquam erat volutpat. Ut wisi enim ad minim veniam, quis nostrud exercitatio ullamcorper suscipit lobortis nisl ut aliquip ex ea commodo consequat. Duis autem vel eum iriure dolor in hendrerit in vulpu

Lorem ipsum dolor sit amet, consectetur adipiscing elit, sed diam nonummy nibh euismod tincidunt ut laoreet dolore magna aliquam erat volutpat. Ut wisi enim ad minim veniam, quis nostrud exercitatio ullamcorper suscipit lobortis nisl ut aliquip ex ea commodo consequat. Duis autem vel eum iriure dolor in hendrerit in vulpu



01

HERRAMIENTA MANUAL Y ALMACENAJE

Set de herramientas y almacenaje

Pág. 17



Carro y set de herramientas

pág. 17



Caja de herramientas, organizadores y gavetas

pág. 19



Maletines y portaherramientas

pág. 22

Herramienta de ajuste

Pág. 28



Llaves fijas

pág. 28



Llaves de carraca

pág. 29



Llave de vaso

pág. 30

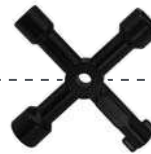

Llaves especiales

pág. 30



Llaves ajustables

pág. 31

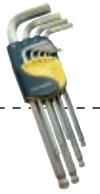

Llaves macho

pág. 32



Atornilladores

pág. 32



Set precisión

pág. 34

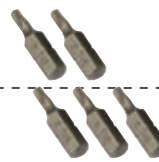

Puntas de atornillar

pág. 35



Set puntas de atornillar

pág. 36



Alicates y tenazas

pág. 37

Pág. 40

Herramienta de corte y abrasión



Corte de metal y PVC

pág. 40



Corte de madera, laminados, PVC y yeso

pág. 42



Corte multimaterial: papel, cartón, PVC...

pág. 43



Formones, escofinas y limas

pág. 44



Cepillos de alambre

pág. 45

Herramienta para percutir

Pág. 46



Martillos, mazas
y macetas
pág. 46



Percusión y corte
pág. 48

Herramienta de aplicación

Pág. 52

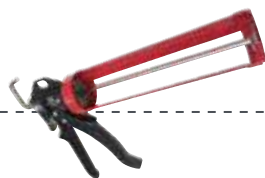

Pistolas
pág. 52



Accesorios para anclaje
químico
pág. 55

Pág. 49

Herramienta de fijación



Sargentos y pinzas
pág. 49



Remachadores
y grapadoras
pág. 51

Pág. 57

01.1 SOLDADURA

Accesorios para soldar



Máscaras de soldar
pág. 57



Pinzas para soldar
y electrodos
pág. 58



02

ACCESORIOS Y CONSUMIBLES

Perforación

Pág. 60



Brocas y extractores de tornillos

pág. 60

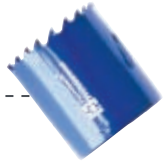

Corona perforadora multiuso

pág. 66



Discos de corte

pág. 67



Discos abrasivos

pág. 70



Cuchillas, cepillo eléctrico

pág. 71



Lijas para lijadora electroportátil

pág. 72



Cepillos de alambre

pág. 74

Pág. 67

Corte y abrasión

CONSTRUCCIÓN 03

Herramientas para yeso, cemento y mortero

Pág. 77

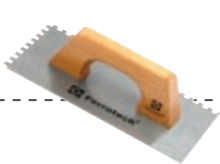

Llanas y talochas

pág. 77



Paletas, paletines y espátulas

pág. 81



Cubos y espuelas

pág. 83

Pág. 84

Suelos de goma

Herramientas de corte y percusión

Pág. 85



Mazas y macetas

pág. 85



Cortafíos, punteros y alcotanas

pág. 86



Suelo de goma

pág. 84

Palas y carretillas

Pág. 87



Palas

pág. 87



Carretillas

pág. 89

Pág. 91

Mallas y señalización

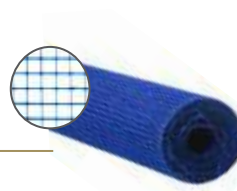

Mallas

pág. 91



Cinta señalización

pág. 92

EPI

Pág. 93



Calzado de seguridad

pág. 93

03.1 HERRAMIENTAS DE MEDICIÓN

Pág. 97

Herramientas de medición

Nivelación y marcajes

Pág. 99

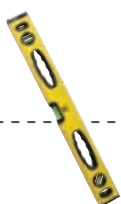

Plomadas y niveles

pág. 99



Marcaje

pág. 101



Flexómetros

pág. 97



Calibre y escuadras

pág. 98

04

COMPRESORES Y HERRAMIENTA NEUMÁTICA

Compresores

Pág. 104



Compresores silenciosos

pág. 104



Compresores de correa

pág. 105



Compresores monoblock

pág. 107

Pág. 109

Accesorios herramienta neumática



Pistolas de pintura

pág. 109



Pistolas sopladoras

pág. 110



Manómetros y espirales

pág. 110



Clavadoras neumáticas

pág. 113

05

PINTURA Y ACCESORIOS

Pág. 115

Esmaltes y barnices de acabado



Esmaltes y barnices de acabado

pág. 115



Pinturas de preparación

pág. 117



Pinturas especiales

pág. 118



Decapantes y diluyentes

pág. 118

Pinturas en spray

Pág. 120



Pintura y barniz acrílico
pág. 120



Pinturas spray especiales
pág. 122

Pág. 123

Accesorios para pintura



Brochas y pinceles
pág. 123

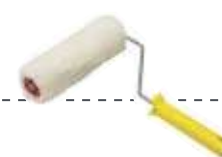

Rodillos y recambios
pág. 124

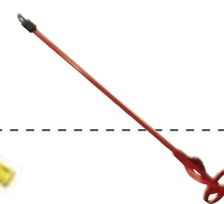

Accesorios pintura
pág. 126

06 ADHESIVOS Y SELLADORES

Siliconas, selladores y masillas

Pág. 129



Siliconas
pág. 129



Selladores
pág. 130



Masillas
pág. 131

Pág. 132

Adhesivos y anclaje químico

LUBRICANTES Y GRASA INDUSTRIAL

06.1

Lubricantes y antioxidantes

Pág. 140



Polímeros y adhesivos
pág. 132



Cintas adhesivas y films
pág. 135



Anclaje químico
pág. 138



Lubricantes en spray
pág. 140



Grasa industrial
pág. 142



Bomba de engrase
pág. 142

06.2 QUÍMICOS PARA LIMPIEZA

Limpieza y desatoros

Pág. 144



Limpiadores e higienizantes en spray
pág. 144



Limpiador de cemento
pág. 145



Desengrasante
pág. 145



Detergente hidrolimpiadoras
pág. 145

07 TREFILERÍA, TORNILLERÍA Y FIJACIONES

Pág. 147

Trefilería

Eslingas, ratches y cintas de amarre

Pág. 150



Alambre galvanizado
pág. 147



Malla galvanizada
pág. 148



Cable galvanizado
pág. 149



Eslingas
pág. 150



Ratches y cintas de amarre
pág. 151

Pág. 152

Tornillería, alcayatas y cancamos



Tornillos pozidrive y torx
pág. 152



Tornillos especiales
pág. 153



Alcayatas y cancamos
pág. 155

Tacos nylon y bridas

Pág. 156



Tacos nylon

pág. 156



Bridas nylon

pág. 158

Pág. 159

Remaches y fijaciones metálicas



Remaches

pág. 159



Ángulos, escuadras y palomillas

pág. 161

08
PODA Y JARDÍN

Mangueras y accesorios de riego

Pág. 163



Mangueras y complementos

pág. 163



Accesorios de riego

pág. 167

Pág. 175

Pulverizadores y fumigación

Herramienta de poda y jardín

Pág. 178



Pulverizadores automáticos

pág. 175



Pulverizadores manuales

pág. 176



Corte y poda

pág. 178



Herramienta de jardín

pág. 182



Herramienta para limpieza

pág. 183

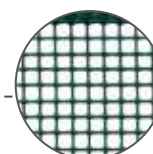

Mallas de protección y delimitación

pág. 185

Accesorios maquinaria jardinería

Pág. 186



Accesorios desbrozadora
pág. 186



Accesorios motosierra
pág. 188



Protección y seguridad
pág. 189

Pág. 186

Toldos de exterior



Toldo de polietileno
pág. 190

ACCESORIOS Y QUÍMICOS PARA PISCINA 09

Bombas y filtraciones

Pág. 192



Filtros laminados y compactos
pág. 192



Electrobomba
pág. 193

Pág. 193

Limpieza de superficie y fondo

Químicos para piscina

Pág. 198



Limpiafondos eléctrico
pág. 193



Recogehojas y cepillo manual
pág. 194



Limpiafondos manual
pág. 196



Cloros multiefectos y rápidos
pág. 198



Tratamiento del agua y limpiadores
pág. 202



Pintura para piscinas
pág. 207



Complementos para el tratamiento del agua
pág. 207

10 CERRAJERÍA

Cerraduras y picaportes de embutir

Pág. 209



Cerraduras de embutir
madera
pág. 209



Picaportes de embutir
madera
pág. 213



Cerraduras de embutir
metal
pág. 215

Pág. 216

Bombillos de latón



Bombillos de serreta
pág. 216



Bombillos de seguridad
pág. 218



Bombillos de seguridad
antibumping
pág. 219

Cerros y cerraduras de sobreponer

Pág. 220



Cerradura de sobreponer
pág. 220



Cerros de sobreponer
pág. 221



Cerrojo alta seguridad
pág. 222

Pág. 223

Candados



Candados de latón
pág. 223

11

FERRETERÍA Y HOGAR

Elevación y utillaje

Pág. 226



Carretillas

pág. 226



Escaleras de aluminio

pág. 228

Pág. 232

Material eléctrico



Enrollables

pág. 232



Alargaderas, regletas y extensibles

pág. 233



Conexiones eléctricas

pág. 234

Artículos para el hogar



Aislamiento puertas y ventana

pág. 235



Utensilios de corte

pág. 236



HERRAMIENTA MANUAL Y ALMACENAJE

Ferrotech ofrece una amplísima gama de herramienta manual: de ajuste, de corte y abrasión, para percutir... Herramientas fabricadas con altos estándares de calidad, pensadas para cubrir las necesidades de un gran número de actividades profesionales.

01



Set de herramientas y almacenaje **17**

Carro y set de herramientas	17
Cajas de herramientas, organizadores y gavetas	19
Maletines y portaherramientas	22

Herramienta de ajuste **28**

LLaves fijas	28
LLaves de carraca	29
LLaves de vaso	30
LLaves especiales	30
LLaves ajustables	31
LLaves macho	32
Atornilladores	32
Set precisión	34
Puntas de atornillar	35
Set de puntas de atornillar	36
Alicates y tenazas	37

Herramienta de corte y abrasión **40**

Corte de metal y PVC	40
Corte de madera, laminados, PVC y yeso	42
Corte multimaterial: papel, cartón, PVC...	43
Formones, escofinas y limas	44
Cepillos de alambre	45

Herramienta para percutir **46**

Martillos, mazas y macetas	46
Percusión y corte	48

Herramienta de fijación **49**

Sargentos y pinzas	49
Remachadoras y grapadoras	51

Herramienta de aplicación **52**

Pistolas	52
Accesorios para andaje químico	55



Set de herramientas y almacenaje



Carro y set de herramientas



Carro de herramientas

- 4 bandejas con una gran variedad de herramientas + 3 cajones para almacenamiento.
- Herramientas cromo vanadio.
- Gran dureza.

4 bandejas con herramientas incluidas

Bandeja 1:
83 pzas. Llaves de vaso 1/4" y 1/2".



Bandeja 2:
19 pzas. Llaves hexa, mango "T" y llaves combinadas.



Bandeja 3:
34 pzas. Atornilladores Ph y Torx punta imantada. Atornilladores electricista y de precisión.



Bandeja 4:
9 pzas. Alicates, martillo y maza.



Carro de herramientas 145 piezas

Código	Medida	Referencia	
20522	722x445x932mm	CH05	1

Maletín set llaves de vaso

- Llaves de vaso de gran resistencia, cromo vanadio Crv 50Bv30.
- Todo tipo de accesorios para un alto rendimiento.
- Adaptadores para facilitar el trabajo en sitios difíciles.
- Mangos de carracas ergonómico para un mejor manejo.



Maletín set 94 piezas llaves de vaso CV

Código	Medida	Referencia	
25794	-	LLV-94CV	1

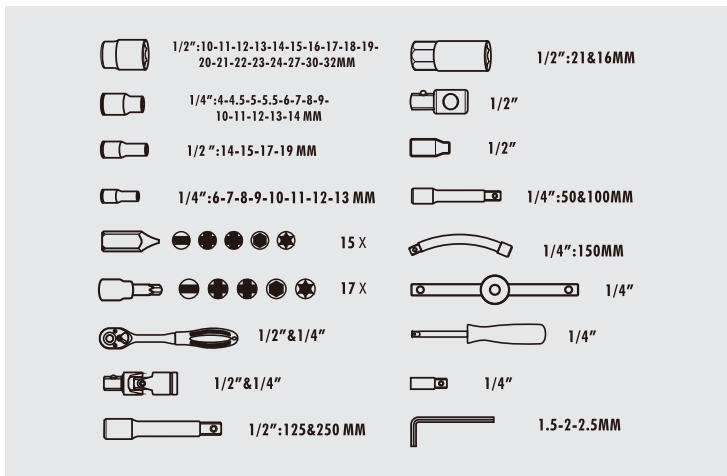
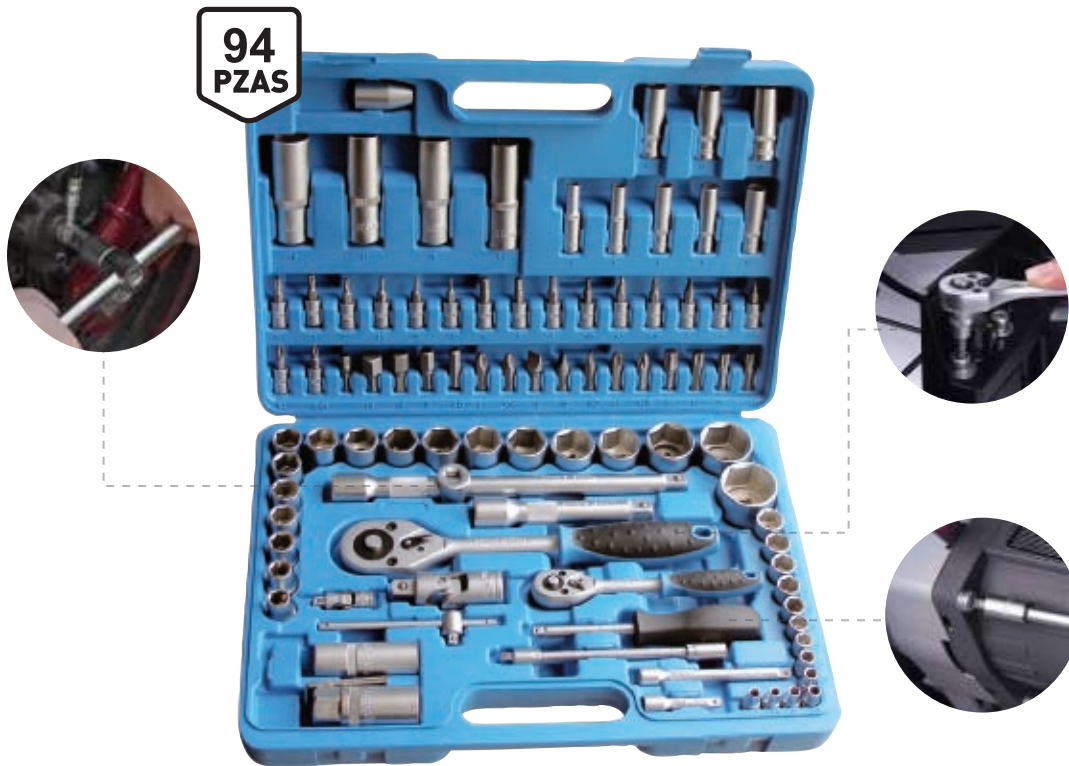

Cajas de herramientas, organizadores y gavetas



Caja de herramientas Ref. CH01

- Cierre de plástico.
- 3 organizadores en la tapa.
- Bandeja interior extraíble.



PP de alto impacto

Organizadores en la tapa



Bandeja extraíble



Caja cierre de plástico, organizador en la tapa y bandeja extraíble

Código	Medida	Referencia	
20075	320x165x136mm	CH01-13	6
20076	410x209x195mm	CH01-16	6
20077	432x250x238mm	CH01-18	6
20078	535x291x280mm	CH01-21	6



Caja de herramientas Ref. CH02

- Cierre metálico.
- 3 organizadores en la tapa.
- Bandeja interior extraíble.



PP de alto impacto

Organizadores en la tapa



Bandeja extraíble



Caja cierre metálico, organizador en la tapa y bandeja extraíble

Código	Medida	Referencia	
20079	320x155x139mm	CH02-13	6
20080	413x212x186mm	CH02-16	6
20081	486x267x242mm	CH02-19	6
20082	564x310x310mm	CH02-22	4



Caja cierre de plástico, organizador en la tapa y bandeja doble desplegable

Código	Medida	Referencia	
20083	434x250x238mm	CH03-17	6
20084	510x290x280mm	CH03-20	6

Caja de herramientas Ref. CH03

- Cierre de plástico.
- 3 organizadores en la tapa.
- Organizadores interiores.



PP de alto impacto

Organizadores en la tapa



Bandeja doble con organizadores interiores



Arcón cierre metálico, ruedas y asas, con organizador en la tapa y bandeja extraíble

Código	Medida	Referencia	
20085	595x380x420mm	CH04	2

Arcón de herramientas Ref. CH04

- Cierre metálico.
- 2 organizadores en la tapa.
- Bandeja interior extraíble.
- Superficie antideslizante.
- Asa extensible.
- Ruedas para facilitar el transporte.



PP de alto impacto



Superficie antideslizante

Organizadores en la tapa y asa extensible



Bandeja interior extraíble





Maletín organizador Ref. OP01

- Cierre de plástico.
- Divisores extraíbles para poder guardar elementos de distintos tamaños.
- Asa para transporte.



PP de alto impacto

Divisores interiores extraíbles



Organizador cierre de plástico

Código	Medida	Referencia	
20086	326x257x48mm	OP01-13	12
20087	420x305x61mm	OP01-18	12
20088	510x347x71mm	OP01-24	6



Organizador Ref. OP02

- Cierre de plástico.
- Distintos compartimentos para guardar elementos de diferentes tamaños.



PP de alto impacto

Compartimentos de varios tamaños



Organizador cierre de plástico

Código	Medida	Referencia	
20089	230x150x33mm	OP02-9	24
20090	276x203x42mm	OP02-11	24
20091	324x247x51mm	OP02-13	12



PP de alto impacto



Gaveta apilable

Código	Medida	Referencia	
20466	103x165x75mm	GAV-01	60
25221	125x195x90mm	GAV-02	60
25502	152x245x122mm	GAV-03	60
25549	200x300x130mm	GAV-04	30
25580	217x360x155mm	GAV-05	30
25665	265x420x177mm	GAV-06	20
25667	310x490x195mm	GAV-07	12



Pieza unión gaveta

Código	Referencia		*
20467	GAV-ACC-01	11	
25222	GAV-ACC-02	11	
25532	GAV-ACC-03	11	
25579	GAV-ACC-04	11	
25581	GAV-ACC-05	15	
25666	GAV-ACC-06	15	
25735	GAV-ACC-07	15	

*Cantidad mínima de embalaje para unir 6 gavetas

Maletines y portaherramientas



Maletín ultrarresistente Ref. MAL-01

- Maletín estanco e impermeable.
- Cierre frontal y lateral.
- Divisores interiores.
- Cierre con código de seguridad.



PP de alto impacto

Divisores interiores



Maletín ultrarresistente

Código	Medida	Referencia	
25223	530x400x180mm	MAL-01	1

Estanco



Ultrarresistente



Impermeable



Maleta-Trolley portaherramientas Ref. MAL-01

- Fabricada en EVA+marco reforzado de ABS.
- Compartimento portadocumentos.
- 3 paneles portaherramientas con elasticos.
- Asa extensible.

Asa extensible



Maletín ultrarresistente

Código	Medida	Referencia	
94514	460x480x240mm	PC 120E	1



**Mochila portaherramientas
Ref. 513013**

- Estuche acolchado para tablet o PC.
- 10 bolsillos portaherramientas.
- Espalda acolchada y transpirable.
- Amplio espacio para taladro o atornillador.

Diferentes tipos de compartimentos

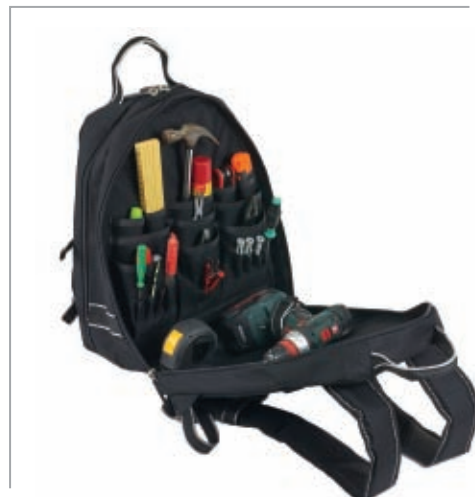

Mochila portaherramientas

Código	Medida	Referencia	
94513	360x430x230mm	513013	1



**Bolsa de mano
Ref. 513011**

- Mango de metal.
- Bandolera acolchada.
- Amplio hueco para taladro o atornillador eléctrico.
- 13 bolsillos para herramientas.
- 10 portaherramientas con elástico.

Sistema de apertura total



Bolsa de mano portaherramientas

Código	Medida	Referencia	
94512	300x380x230mm	513011	1



Bolso de mano
Ref. 513000TB

- Material reforzado.
- Fondo de polietileno rígido.
- Bolsillos interiores y exteriores.
- Correas para herramientas voluminosas.
- Asas y bandolera acolchadas.

Bolso de mano portaherramientas

Código	Medida	Referencia	
94522	240x310x190mm	513000TB	1



Cinturón
Ref. 530TB

- Material reforzado.
- Ajustable de 90 a 120cm.
- Cierre rápido.

Cinturón ajustable

Código	Medida	Referencia	
94503	90/120cm	530TB	10

Bolsa portataladro
Ref. 531TB

- Tejido especial reforzado.
- Bolsillos para puntas de taladro y accesorios.
- Adaptable al cinturón ref. 530TB.



Bolsa portataladro

Código	Medida	Referencia	
94506	-	531TB	9



Bolsa portatijeras
Ref. 524TB

- Material reforzado.
- Adecuado para la mayor parte de las pinzas y tijeras de podar.
- Clip metálico apto para cualquier cinturón.

Bolsa portatijeras

Código	Medida	Referencia	
94505	-	524TB	9

Bolsa portaherramientas
Ref. 522TB

- Mosquetón para rollos, cinta o llaves.
- Cierre de velcro ancho.
- Clip metálico apto para cualquier cinturón.
- Adaptable al cinturón ref. 530TB.



Bolsa portaherramientas

Código	Medida	Referencia	
94507	-	522TB	9



Bolsa portacúter
Ref. 536TB

- Incluye portaláminas y portabolígrafo.
- Clip metálico apto para cualquier cinturón.

Bolsa portacúter

Código	Medida	Referencia	
94515	-	536TB	9

Funda portamóvil
Ref. 539TB

- Material reforzado acolchado.
- Incluye portabolígrafo.
- Clip metálico apto para cualquier cinturón.



Funda portamóvil

Código	Medida	Referencia	
94516	-	539TB	9



Bolsa portaherramientas
Ref. 529TB

- Enganche para cinturón.
- Arnés para rollo de cinta.
- Sistema de fijación para bolsillo posterior del pantalón.

Bolsa portaherramientas abierta

Código	Medida	Referencia	
94508	-	529TB	9

Bolsa portaherramientas
Ref. 533TB

- Bolsillos externos e internos.
- Asa para martillo.
- Adaptable al cinturón ref. 530TB.



Bolsa portaherramientas abierta

Código	Medida	Referencia	
94517	-	533TB	6



Bolsa portaherramientas
Ref. 534TB

- Bolsillos externos e internos.
- Mosquetón de plástico.
- Adaptable al cinturón ref. 530TB.

Bolsa portaherramientas abierta

Código	Medida	Referencia	
94518	-	534TB	6



Bolsa portaherramientas Ref. 535TB

- Especialmente indicada para electricistas.
- Cadena para rollo de cinta.
- Adaptable al cinturón ref. 530TB.

Bolsa portaherramientas abierta

Código	Medida	Referencia	
94509	-	535TB	6



Bolsa portaclavos/tornillos Ref. 537TB

- Material reforzado doble.
- Amplia capacidad.
- Adaptable al cinturón ref. 530TB.

Bolsa portaclavos/tornillos

Código	Medida	Referencia	
94504	-	537TB	9



Cinturón de trabajo Ref. 546TB

- Especialmente indicado para carpinteros.
- Material reforzado.
- Enganche para martillo.
- Amplio bolsillo central.
- Cierre metálico de fácil apertura.

Cinturón de trabajo

Código	Medida	Referencia	
94510	-	546TB	6



Cinturón portaherramientas Ref. 52180TB

- 15 bolsillos para útiles y accesorios con un asa para martillo.
- Funda para atornillador.
- Bolsillo para flexómetro.
- Ajustable de 90 a 120cm.
- Cierre rápido.

Cinturón portaherramientas

Código	Medida	Referencia	
94511	90/120cm	52180TB	6



**Bolso portaherramientas
Ref. 550NT**

- Correa bandolera.
- Arnés para rollo de cinta.
- Enganche de sistema anticaídas para herramientas.
- Adaptable al cinturón ref. 530TB.

Bolso portaherramientas abierto

Código	Medida	Referencia	
94523	-	550NT	6



**Bolso portaherramientas
Ref. 543TB**

- Correa bandolera.
- Bolsillo para teléfono.
- Bolsillos internos y externos.

Bolso portaherramientas

Código	Medida	Referencia	
94521	-	543TB	5



**Bolso portaherramientas
Ref. 556TB**

- Para herramientas de precisión.
- Bolsillo interior acolchado.
- Opción asa, bandolera o enganche de cinturón.

Bolso portaherramientas cerrado

Código	Medida	Referencia	
94519	-	556TB	6

Bolso con sistema de cierre



**Riñonera portaherramientas
Ref. 545TB**

- Material reforzado.
- Cinturón regulable.
- Bolsillos internos y externos.

Maletín ultrarresistente

Código	Medida	Referencia	
94520	-	545TB	6



Herramienta de ajuste

Llaves fijas

Llaves fijas dobles boca abierta

- Cromo vanadio.
- Gran dureza.
- Cuerpo pulido, alta resistencia a la oxidación.



Llave fija doble boca abierta

Código	Medida	Referencia	
24024	6-7mm	LLF6-7CV	6
23996	8-9mm	LLF8-9CV	6
23997	10-11mm	LLF10-11CV	6
23998	12-13mm	LLF12-13CV	6
23999	14-15mm	LLF14-15CV	6
24000	16-17mm	LLF16-17CV	6
24002	18-19mm	LLF18-19CV	6
24004	20-22mm	LLF20-22CV	6
24005	21-23mm	LLF21-23CV	6
24007	24-26mm	LLF24-26CV	6
24008	25-28mm	LLF25-28CV	6
24009	27-29mm	LLF27-29CV	6
24010	30-32mm	LLF30-32CV	6

8
PZAS



10
PZAS



Set 8 llaves fijas doble boca abierta. Expositor plástico



6-7 • 8-9 • 10-11 • 12-13 • 14-15
16-17 • 18-19 • 20-22

Código	Medida	Referencia	
24082	6-7/20-22	S8LLFCV	6

Set 10 llaves fijas doble boca abierta. Funda nylon



6-7 • 8-9 • 10-11 • 12-13 • 14-15 • 16-17
18-19 • 20-22 • 21-23 • 24-26

Código	Medida	Referencia	
24011	6-8/24-26	S10LLFCV	3

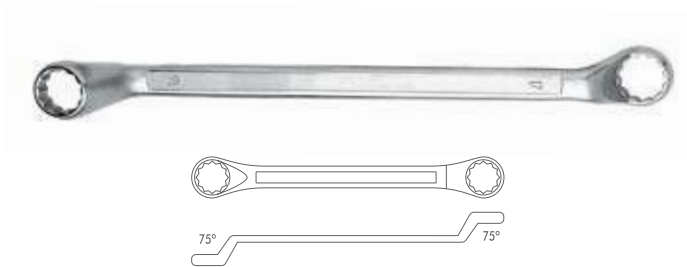

Llave de estrella acodada

- Cromo vanadio.
- Gran dureza.
- Cuerpo pulido, alta resistencia a la oxidación.

Llaves estrella codo

Código	Medida	Referencia	
24335	6-7	LLEC6-7CV	6
24336	8-9	LLEC8-9CV	6
24337	10-11	LLEC10-11CV	6
24338	12-13	LLEC12-13CV	6
24339	14-15	LLEC14-15CV	6
24340	16-17	LLEC16-17CV	6
24341	18-19	LLEC18-19CV	6

Código	Medida	Referencia	
24342	20-22	LLEC20-22CV	6
24343	21-23	LLEC21-23CV	6
24346	24-26	LLEC24-26CV	6
24347	25-28	LLEC25-28CV	6
24348	27-29	LLEC27-29CV	6
24349	30-32	LLEC30-32CV	6

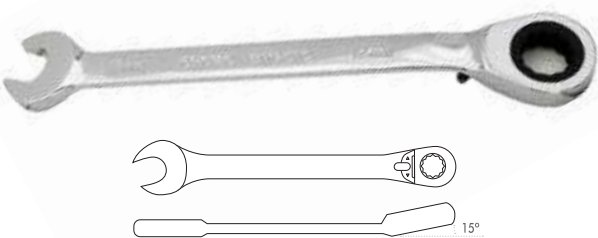

Llaves de carraca

Combinada de carraca reversible

- Cromo vanadio.
- 72 dientes - 5°.
- Cuerpo pulido, alta resistencia a la oxidación.

Llaves combinada carraca 15°

Código	Medida	Referencia	
27095	8mm	LLCR15G-8CV	5
27096	9mm	LLCR15G-9CV	5
27097	10mm	LLCR15G-10CV	5
27098	11mm	LLCR15G-11CV	5
27099	12mm	LLCR15G-12CV	5
27100	13mm	LLCR15G-13CV	5
27101	14mm	LLCR15G-14CV	5
27102	15mm	LLCR15G-15CV	5
27103	16mm	LLCR15G-16CV	5
27104	17mm	LLCR15G-17CV	5
27105	18mm	LLCR15G-18CV	5

Código	Medida	Referencia	
27106	19mm	LLCR15G-19CV	5
27107	20mm	LLCR15G-20CV	5
27108	21mm	LLCR15G-21CV	5
27109	22mm	LLCR15G-22CV	5
27110	23mm	LLCR15G-23CV	5
27111	24mm	LLCR15G-24CV	5
27112	25mm	LLCR15G-25CV	5
27113	26mm	LLCR15G-26CV	5
27114	27mm	LLCR15G-27CV	5
27115	28mm	LLCR15G-28CV	5
27116	30mm	LLCR15G-30CV	5
27117	32mm	LLCR15G-32CV	5



Set 7 llaves combinadas con carraca reversible

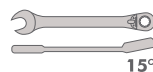

8 • 10 • 13 • 14 • 15 • 17 • 19

Código	Medida	Referencia	
24012	8/19	S7LLCCV	4

Llave de carraca reversible

- Cromo vanadio.
- 72 dientes.
- Cuerpo pulido, alta resistencia a la oxidación.
- Mango curvo bimaterial.



Llave de carraca

Código	Medida	Referencia	
24932	1/4	LL-CAR1/4	6
24933	3/8	LL-CAR3/8	6
24934	1/2	LL-CAR1/2	6

Llaves de vaso

Llave de vaso hexagonal

- Cromo vanadio.
- Cuerpo pulido, alta resistencia a la oxidación.



Llave vaso hexagonal

1/4"

Código	Medida	Referencia	
27053	4mm	LLV-1/4"4mm	24
27055	5mm	LLV-1/4"5mm	24
27057	6mm	LLV-1/4"6mm	24
27058	7mm	LLV-1/4"7mm	24
27059	8mm	LLV-1/4"8mm	24
27060	9mm	LLV-1/4"9mm	24
27061	10mm	LLV-1/4"10mm	24
27062	11mm	LLV-1/4"11mm	24
27063	12mm	LLV-1/4"12mm	24
27064	13mm	LLV-1/4"13mm	24
27065	14mm	LLV-1/4"14mm	24

1/2"

Código	Medida	Referencia	
27066	8mm	LLV-1/2"8mm	24
27067	9mm	LLV-1/2"9mm	24
27068	10mm	LLV-1/2"10mm	24
27069	11mm	LLV-1/2"11mm	24
27070	12mm	LLV-1/2"12mm	24
27071	13mm	LLV-1/2"13mm	24
27072	14mm	LLV-1/2"14mm	24
27073	15mm	LLV-1/2"15mm	24
27074	16mm	LLV-1/2"16mm	24
27075	17mm	LLV-1/2"17mm	24
27076	18mm	LLV-1/2"18mm	24
27077	19mm	LLV-1/2"19mm	24

1/2"

Código	Medida	Referencia	
27078	20mm	LLV-1/2"20mm	12
27079	21mm	LLV-1/2"21mm	12
27080	22mm	LLV-1/2"22mm	12
27081	23mm	LLV-1/2"23mm	12
27082	24mm	LLV-1/2"24mm	12
27083	25mm	LLV-1/2"25mm	12
27084	26mm	LLV-1/2"26mm	12
27085	27mm	LLV-1/2"27mm	12
27086	28mm	LLV-1/2"28mm	12
27087	29mm	LLV-1/2"29mm	12
27088	30mm	LLV-1/2"30mm	12
27089	32mm	LLV-1/2"32mm	12

Llaves especiales

Llave multifunción 4 en 1

- 4 cabezas distintas.
- Para apertura de armarios y contadores de luz, agua, gas.
- Aleación de zinc de gran calidad y durabilidad.

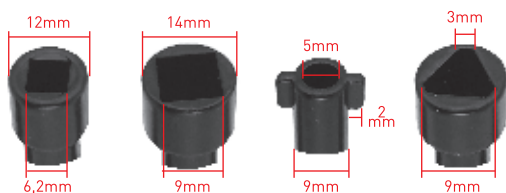

Llave multifunción 4 en 1

Código	Medida	Referencia	
27134	72x72x13mm	LLCR-4/1	24



Llave inglesa graduada láser DIN3117

Código	Medida	Referencia	
22494	150mm	LIL150	1
22495	200mm	LIL200	1
22496	250mm	LIL250	1
22497	300mm	LIL300	1
25090	375mm	LIL375	1



Llave inglesa graduada láser DIN3117, mango bimaterial

Código	Medida	Referencia	
25059	200mm	LIL200-B	1
25060	250mm	LIL250-B	1
25061	300mm	LIL300-B	1



Llaves ajustables

Llave ajustable moleta central

- Cromo vanadio.
- Gran dureza.
- Cuerpo pulido, alta resistencia a la oxidación.

Marcaje graduación láser



Llave Stillson acero

Código	Medida	Referencia	
25089	250mm	LTAC250	24
22483	350mm	LTAC350	24
22484	450mm	LTAC450	12
22485	600mm	LTAC600	8
22486	900mm	LTAC900	5

Llave Stillson

- Para trabajos de fontanería.
- Gran resistencia.
- Mango reforzado en doble T de una pieza.
- Boca estriada gran dureza.

Boca estriada de gran dureza



Más ligera

Llave Stillson aluminio

Código	Medida	Referencia	
22479	350mm	LTAL350	25
22480	450mm	LTAL450	10
22481	600mm	LTAL600	10
22482	900mm	LTAL900	4

Llaves macho

Jgo. llaves Allen

- Cromo vanadio.
- Cuerpo pulido, alta resistencia a la oxidación.
- Punta bola.



Set 9 llaves Allen, punta bola

1,5 • 2 • 2,5 • 3 • 4 • 5 • 6 • 8 • 10

Código	Medida	Referencia	
21951	1,5-10mm	ALLEN9	6

Jgo. llaves Torx

- Cromo vanadio.
- Cuerpo pulido, alta resistencia a la oxidación.
- Punta bola.



Set 8 llaves Torx inviolable

9 • 10 • 15 • 20 • 25 • 27 • 30 • 40

Código	Medida	Referencia	
26377	9-40mm	TORX/18	12

Atornilladores

Atornillador Premium

- Cromo molibdeno.
- Mango bimaternal ergonómico.
- Punta imantada, protección especial antióxido.



Varilla de Ac.
Molibdeno
Vanadio

Punta imantada y protección antióxido



Boca plana recta

Código	Medida	Referencia	
24717	3,0x75mm	PREM-BP3,0x75R	12
24718	3,5x100mm	PREM-BP3,5x100R	12
24719	4,0x100mm	PREM-BP4,0x100R	12
24720	5,5x125mm	PREM-BP5,5x125R	12
24721	6,5x150mm	PREM-BP6,5x150R	12



Boca plana ancha

Código	Medida	Referencia	
24713	5,5x125mm	PREM-BP5,5x125A	12
24714	6,5x150mm	PREM-BP6,5x150A	12
24715	8,0x175mm	PREM-BP8,0x175A	12
24716	9,5x200mm	PREM-BP9,5x200A	8



Boca Philips



Código	Medida	Referencia	
24722	PH0x75mm	PREM-PH0x75	12
24723	PH1x100mm	PREM-PH1x100	12
24724	PH2x125mm	PREM-PH2x125	12
24725	PH3x150mm	PREM-PH3x150	12



Boca Torx inviolable



Código	Medida	Referencia	
24729	T8x75mm	PREM-T8x75	12
24730	T9x75mm	PREM-T9x75	12
24731	T10x75mm	PREM-T10x75	12
24732	T15x100mm	PREM-T15x100	12
24733	T20x100mm	PREM-T20x100	12
24734	T25x100mm	PREM-T25x100	12
24735	T27x125mm	PREM-T27x125	12
24736	T30x150mm	PREM-T30x150	12
24737	T40x150mm	PREM-T40x150	12



Boca Pozidrive



Código	Medida	Referencia	
24726	PZ0x75mm	PREM-PZ0x75	12
24727	PZ1x100mm	PREM-PZ1x100	12
24728	PZ2x125mm	PREM-PZ2x125	12

5
PZAS



7
PZAS



Set 5 atornilladores

4x100 • 10 • 5,5x125 • 6,5x150

1x100 • 2x125

Código	Medida	Referencia	
24742	PH(1-2)BP(4-5,5-6,5)	PREM-S5PCS	24

Set 5 atornilladores

0x75 • 1x100 • 2x125 • 3x150 • 4x200

Código	Medida	Referencia	
26660	PH(0-1-2-3-4)	PREM-S5PCS	24

Set 7 atornilladores con soporte

3x75 • 4x100 • 5,5x150 • 6,5x150A • 8x150A

1x100 • 2x125

1x100 • 2x125

Código	Medida	Referencia	
24753	PH(1-2)BP(3-4-5,5)PZ(1-2)	PREM-S7PCS	12

Atornillador Premium aislado

- Cromo molibdeno.
- Mango bimaterial ergonómico.
- Punta imantada, protección especial antióxido.
- Aislado para trabajos de electricidad.



Varilla de Ac.
Molibdeno
Vanadio

Set 6 atornilladores aislados

- 3x75 • 4x100 • 5,5x125 • 6,5x150
- 1x100 • 2x125



Código	Medida	Referencia	
26661	PH(1-2)BP(3-4-5,5-6,5)	PREM-S6PCS	24

6
PZAS



Boca plana recta para electricista

Código	Medida	Referencia	
24744	0,4x2,5x80	PREM-BP2,5x80E	12
24745	0,8x4x100	PREM-BP4x100E	12
24746	1,0x5,5x125	PREM-BP5,5x125E	12
24747	1,2x6,5x150	PREM-BP6,5x150E	12



Boca Philips para electricista

Código	Medida	Referencia	
24748	PH0x80mm	PREM-PH0x80E	12
24749	PH1x100mm	PREM-PH1x100E	12
24750	PH2x150mm	PREM-PH2x150E	12

Set precisión

Atornilladores precisión

- Cromo molibdeno.
- Mango bimaterial.
- Especial para dispositivos electrónicos.



Varilla de Ac.
Molibdeno
Vanadio

Set 6 atornilladores de precisión

- 1,5 • 2 • 3
- 000 • 0 • 1

Código	Medida	Referencia	
24751	50mm	PRECISION 01	10

6
PZAS



6
PZAS



Set 6 atornilladores de precisión Torx inviolable

- 5 • 6 • 7 • 8 • 9 • 10

Código	Medida	Referencia	
24752	50mm	PRECISION 02	10

Imanta cuando lo introduces



Desimanta cuando lo desizas



5 puntas de atornillar Philips

Código	Medida	Referencia	
24026	1x25mm	5PA-PH1-25	24
24030	2x25mm	5PA-PH2-25	24
24034	3x25mm	5PA-PH3-25	24
24025	1x50mm	5PA-PH1-50	12
24029	2x50mm	5PA-PH2-50	12
24033	3x50mm	5PA-PH3-50	12



5 puntas de atornillar Pozidrive

Código	Medida	Referencia	
24028	1x25mm	5PA-PZ1-25	24
24032	2x25mm	5PA-PZ2-25	24
24036	3x25mm	5PA-PZ3-25	24
24027	1x50mm	5PA-PZ1-50	12
24031	2x50mm	5PA-PZ2-50	12
24035	3x50mm	5PA-PZ3-50	12

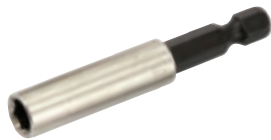

Adaptador magnético S2 para puntas de atornillar

Código	Medida	Referencia	
24014	S2	APM-S2	12



Acero Cromo Vanadio siliconado

Puntas de atornillar

Puntas de atornillar 1/4"

- Cromo vanadio siliconado S2.
- Gran dureza y resistencia.
- Alta resistencia a la oxidación.



5 puntas de atornillar Torx invariable

Código	Medida	Referencia	
24040	10x25mm	5PA-TI10-25	24
24041	15x25mm	5PA-TI15-25	24
24042	20x25mm	5PA-TI20-25	24
24043	25x25mm	5PA-TI25-25	24
24044	27x25mm	5PA-TI27-25	24
24045	30x25mm	5PA-TI30-25	24
24046	40x25mm	5PA-TI40-25	24
24047	50x25mm	5PA-TI50-25	24
27623	10x50mm	5PA-TI10-50	12
27624	15x50mm	5PA-TI15-50	12
27625	20x50mm	5PA-TI20-50	12
27626	25x50mm	5PA-TI25-50	12
27627	27x50mm	5PA-TI27-50	12
27628	30x50mm	5PA-TI30-50	12
27629	40x50mm	5PA-TI40-50	12
27630	50x50mm	5PA-TI50-50	12



Estuche 17 pzas. puntas de atornillador 25mm

- 3 • 4 • 5 • 6 • 7
- 1 • 2 • 3
- 0 • 1 • 2 • 3
- 15 • 20 • 30 • 40

Código	Medida	Referencia	
21952	25mm	EST17PCS	12

Set puntas de atornillar



Acero Cromo Vanadio
siliconado

Set puntas de atornillar 1/4"

- Gran variedad de puntas.
- Cromo vanadio siliconado S2.
- Gran dureza y resistencia.
- Alta resistencia a la oxidación.

- Incluye adaptador rápido.
- Color identificativo para cada tipo de punta.

- PH 1 • 2 • 2 • 3 H 3 • 4 • 5 • 6
- SL 3 • 4 • 5 • 6 T 10 • 15 • 20 • 25 • 27 • 30 • 40
- PZ 1 • 2 • 2 • 3 TxH 10 • 15 • 20 • 25 • 27 • 30 • 40

Estuche 32 piezas, puntas de atornillar 25mm

Código	Medida	Referencia	
21950	25mm	EST32PCS	10



32
PZAS

- POZZI. pz.0, pz.1, pz.2 (5x), pz.3.
- CUADRADAS. s0, s1, s2, s3.
- PLANAS. 3, 4, 4.5, 5, 5.5, 6, 6.5, 7, 8.
- PUNTAS PARA QUITAR ANTENA. 4, 6, 8, 10.
- TORX. t8, t10, t15, t20, t25, t27, t30, t40, t45.
- TRI-WING. 6, 8, 10.
- TORX SEGURIDAD. t8, t10, t15, t20, t25, t27, t30, t35, t40.
- 'FOUR-WING'. 1, 2, 3, 4.
- ALLEN. 1.5, 2, 2.5, 3, 4, 5, 5.5, 6, 8.
- FORMA DE X. 1, 2, 3.
- HEX AMERICANAS. 1/16, 5/64, 3/32, 7/64, 1/8, 9/64, 5/32, 3/16, 7/32, 1/4.
- XZN. m5, m6, m8.
- ALLEN INVIOABLES. 2, 2.5, 3, 4, 5, 6.
- ALLEN INVIOABLES. 5/32, 9/64, 1/8, 7/64, 3/32, 5/64.
- 1 ud. herramienta para tuercas de mariposa.
- 1 ud. portapuntas.
- 1 ud. portapuntas magnético.
- 1 ud. extensión 1/4" sq. x 1/4" x 2".
- 1 ud. extensión 1/4"sq. x 1/4" x 1".



Cromo Vanadio



Punta imantada

Estuche 100 puntas de atornillar 1/4" x 60mm

Código	Medida	Referencia	
27495	1/4" x 60mm	EST100PCS	12



100
PZAS



Alicate estándar

Código	Medida	Referencia	
23978	160mm	ALS160CV	6
23979	180mm	ALS180CV	6
23980	200mm	ALS200CV	6



Alicate corte diagonal reforzado

Código	Medida	Referencia	
23985	180mm	ALD180CV	6

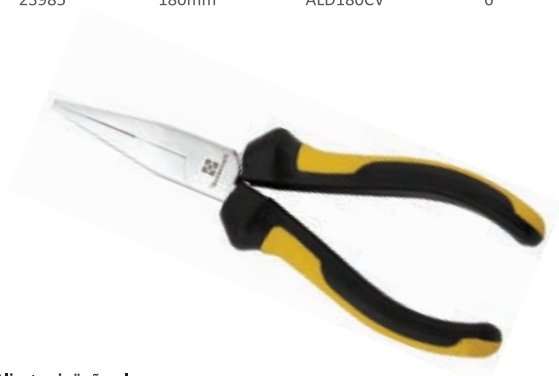

Alicate cigüeña plano

Código	Medida	Referencia	
23986	160mm	ALCP160CV	6



Alicate cigüeña redondo

Código	Medida	Referencia	
23987	160mm	ALCR160CV	6

Alicates y tenazas



Alicates

- Cromo vanadio.
- Mango bimaterial ergonómico.
- Gran dureza y resistencia.
- Alta resistencia a la oxidación.



Alicate corte diagonal

Código	Medida	Referencia	
23981	140mm	ALD140CV	6
23982	160mm	ALD160CV	6



Alicate cigüeña con corte

Código	Medida	Referencia	
23983	160mm	ALD160CV	6
23984	200mm	ALD200CV	6



Alicate punta curva

Código	Medida	Referencia	
23988	160mm	APC160CV	6
23989	200mm	APC200CV	6

Set alicates de precisión



- Cromo vanadio.
- Mango bimaterial.
- Gran dureza y resistencia.
- Alta resistencia a la oxidación.
- Para múltiples trabajos de precisión.

Set 6 alicates de precisión

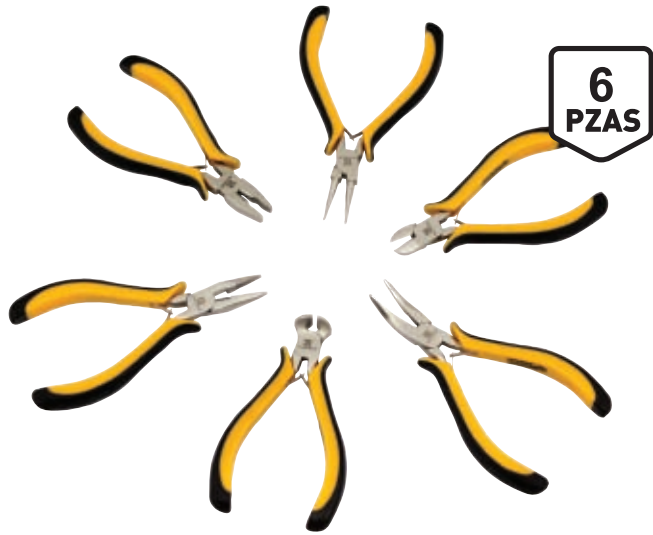

Código	Medida	Referencia	
23976	120mm	SMA6CV	5

Alicates aislados



- Cromo vanadio.
- Mango bimaterial ergonómico.
- Gran dureza y resistencia.
- Alta resistencia a la oxidación.
- Aislado para trabajos de electricidad.



Alicate estándar para electricista

Código	Medida	Referencia	
27139	180mm	ALE180ELEC	6



Alicate corte para electricista

Código	Medida	Referencia	
27140	160mm	ALC160ELEC	6

Alicates especiales



- Cromo vanadio.
- Mango bimaterial ergonómico.
- Gran dureza y resistencia.
- Alta resistencia a la oxidación.
- Alicates para tareas específicas.



Alicates pelacables

Código	Medida	Referencia	
23990	160mm	P160CV	6



Alicates para arandela de presión

Código	Medida	Referencia	
26010	10-50mm	ALAP	6



Alicate pico de loro

Código	Medida	Referencia	
23977	250mm	LLPL250CV	6



Sacabocados de estrella Ø2mm a 5mm

Código	Medida	Referencia	
26441	Ø2/5mm	SE01	10

Tenazas

- Gran dureza y resistencia.
- Alta resistencia a la oxidación.
- Tenazas específicas para diferentes trabajos.



Tenaza de fuerza encofrador. Acero al carbono

Código	Medida	Referencia	
27141	300mm	TFE-300	6



Cromo Vanadio

Tenaza de carpintero cromo vanadio

Código	Medida	Referencia	
23991	160mm	TCP160CV	6
23992	200mm	TCP200CV	6
23993	250mm	TCP250CV	6

Boca corta-alambre

Tuerca regulación de apertura



Palanca de desbloqueo rápido

Tenaza de presión con corte

Código	Medida	Referencia	
27443	190mm	TPR-C190	6
27142	250mm	TPR-C250	6



Herramienta de corte y abrasión

Corte de metal y PVC

Cortatubos

- Hojas de triple duración para aplicaciones de plomería, electricidad, instalación de aire acondicionado, automotriz y bricolaje.
- Materiales de alta calidad.



Cortatuberías de PVC

Código	Medida	Referencia	
26012	42mm	CTPVC	48



Cortatubos de cojinetes y cuchilla de repuesto

Código	Medida	Referencia	
26011	6-42mm	CTC	48
25108	6-42mm	CTC-R	1000

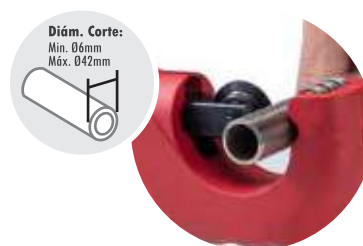

Cortavarillas

- Cabeza de aleación de acero endurecido para una máxima vida útil de la hoja.
- Mango ergonómico.



Cortavarillas

Código	Medida	Referencia	
22487	300mm	CVA300	40
22488	350mm	CVA350	20
22489	450mm	CVA450	10
22490	600mm	CVA600	10
22491	750mm	CVA750	5
22492	900mm	CVA900	5
22493	1050mm	CVA1050	5



Tijera corta chapas

- Efecto de palanca y acción de corte combinada.
- Alta resistencia a la oxidación.
- Válido para el corte de aluminio, láminas de PVC, mallas de acero, piel, cobre y plástico.

Tijera cortachapa, mango ergonómico y bimaterial

Código	Hoja	Referencia	
26442	Cromo van.	TCH01	6



Sierras de arco

- Mango ergonómico de goma, para mejor agarre.
- Válido para el corte de metal, PVC.



Sierra de arco para metal, mango ergonómico y bimaterial

Código	Medida	Referencia	
25304	300mm	SM-300	6



Sierra de arco de aluminio, mango ergonómico y bimaterial

Código	Medida	Referencia	
24023	300mm	S-ALUM	6



Hoja sierra 1 corte carbono

Código	Hoja
10D-100	1 corte

Corte de madera, laminados, PVC y yeso

Serruchos

- Mango ergonómico bimaternal.
- Hoja de acero al carbono, gran dureza.
- Afilado de larga duración, corte dinámico, limpio y fácil.

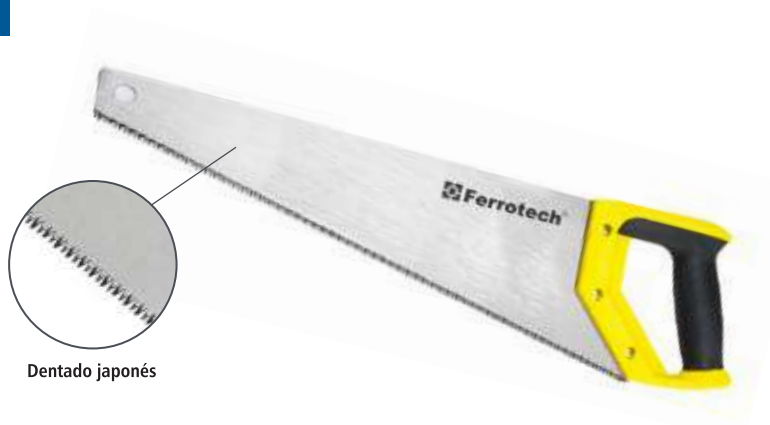

Dentado japonés

Serrucho carpintero dentado japonés, mango bimaternal

Código	Medida	Referencia	
26440	500mm	SPRO01	12

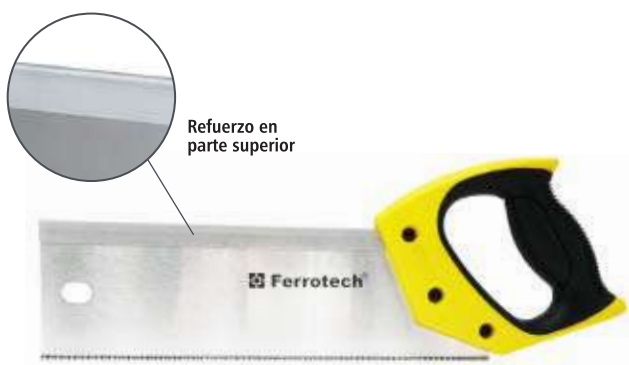

Refuerzo en parte superior

Serrucho de costilla, mango bimaternal

Código	Medida	Referencia	
26955	300mm	SERR/COS-300	10



Cortes rectos y circulares

Serrucho de punta, mango bimaternal

Código	Medida	Referencia	
26954	300mm	SERR/PUN-300	10



Punta afilada corte sin esfuerzo

Serrucho para cartón-yeso, mango bimaternal

Código	Medida	Referencia	
27279	160mm	SERR-Y/8D"	12





Cúter con rueda. Cuchilla 18mm

Código	Medida	Referencia	
23116	18x100mm	CU001	24



+5

Hoja de repuesto



Recarga automática

Cúter recargable automático. Cuchilla 18mm

Código	Medida	Referencia	
23117	18x100mm	CU002-18AUTO	24
24840	9x100mm	CU002-9AUTO	12



+5

Hoja de repuesto



Recarga automática



Cúter con bloqueo



Superficie estriada antideslizante

Cúter aluminio estriado

Código	Medida	Referencia	
23452	9x100mm	CU005-9AUTO	24
23451	18x100mm	CU005-18AUTO	6



Recambio 10 cuchillas para cúter

Código	Medida	Referencia	
20665	100x9mm	HC1009	12
25261	100x18mm	HC10018	24



Recambio 10 hojas. Cuchilla 60x19mm

Código	Medida	Referencia	
25265	60x19mm	HC6019	24



+4

Hoja de repuesto



Recarga automática

Cúter recargable automático. Cuchilla 60x19mm

Código	Medida	Referencia	
25262	60x19mm	CU003AUTO	12



Tijera multiusos electricista

Código	Medida	Referencia	
27138	145mm	TE-145	12



Muesca pelacables



Tijera multiusos electricista*

- Hoja de acero inoxidable.
- Muesca pelacables.
- Hoja microdentada antideslizante.

*No adecuada para trabajos bajo tensión.

Formones, escofinas y limas

Formones

- Mango de madera maciza con anillo metálico.
- Acero cromo vanadio.
- Gran resistencia a la oxidación.
- Hoja preafilada lista para un uso inmediato.



Formón 130mm. Mango madera

Código	Medida	Referencia	
27284	25mm	FOR-CRV/MAD	12
27285	32mm	FOR-CRV/MAD	12
27286	38mm	FOR-CRV/MAD	12

Escofinas

- Mango ergonómico bimaterial.
- Acero al carbono, gran resistencia.

Escofina redonda. Mango bimaterial

Código	Medida	Referencia	
26957	200mm	ES/RED-200	6
26958	250mm	ES/RED-250	6



Limas

- Mango ergonómico bimaterial.
- Acero al carbono, gran resistencia.

Lima cuadrada entrefina. Mango bimaterial

Código	Medida	Referencia	Granulado	
26959	250mm	LIM/CUA-250	Entrefina	6



Lima media caña. Mango bimaterial

Código	Medida	Referencia	Granulado	
27806	250mm	LIM/MC-250	Entrefina	10
26960	250mm	LIM/MC-250	Gruesa	6



Lima plana. Mango bimaterial

Código	Medida	Referencia	Granulado	
26961	250mm	LIM/PL-250	Gruesa	6
26962	300mm	LIM/PL-300	Gruesa	6



Lima triangular. Mango bimaterial

Código	Medida	Referencia	Granulado	
26963	250mm	LIM/TRI-250	Entrefina	6



Lima redonda. Mango bimaterial

Código	Medida	Referencia	Granulado	
26964	250mm	LIM/RED-250	Entrefina	6
26965	250mm	LIM/RED-250	Gruesa	6



Set 12 limas aguja. Trabajos de precisión

**12
PZAS**

6 limas entrefinas
+
6 limas gruesas

-  Cuadrada
-  Media caña
-  Plana paralela
-  Plana punta
-  Redonda
-  Triangular

Código	Medida	Referencia	Granulado	
26970	Ø3X140	S12LA-3x140	Entrefina Gruesa	100

Cepillos de alambre

- Alambre de acero latonado.
- Alta resistencia al desgaste.
- Limpieza y eliminación de pinturas, barnices, cascarilla, óxidos y pequeñas rebabas.



Cepillo manual de alambre recto 0,3x16mm. Mango madera

Código	Medida	Referencia	
27146	300mm	CMA-MAD	12



Cepillo manual alambre ondulado 0,3x20mm. Mango ergonómico

Código	Medida	Referencia	
24098	250mm	CMAO	24



Herramienta para percutir

Martillos, mazas y macetas

Martillos

- Para diferentes aplicaciones.
- Mangos ergonómicos.
- Gran resistencia, fabricación bajo estándares de calidad.



Martillo de carpintero Norma GS DIN1041. Mango de fibra de vidrio

Código	Medida	Referencia	
24862	18mm	MAC18-FV	12
24863	20mm	MAC20-FV	12
24864	22mm	MAC22-FV	6
24865	25mm	MAC25-FV	6
24866	28mm	MAC28-FV	6



Martillo americano 500g. Mango de fibra de vidrio

Código	Peso	Referencia	
24022	500g	M-FV	6



Martillo bola 400g. Mango de fibra de vidrio

Código	Peso	Referencia	
26949	400g	MB-400	6



Martillo uña curva 600g. Mango madera

Código	Peso	Referencia	
27288	600g	MUC-600	6



Cabeza portaclavos imantada

Martillo encofrador 600g. Mango madera

Código	Peso	Referencia	
27274	600g	ME-570	6



Maceta mango fibra de vidrio

Código	Peso	Referencia	
26021	1,0kg	MFV1	6
26022	1,5kg	MFV1.5	6

Macetas y mazas

- Cabeza de aleación de acero forjado de gran dureza.
- Modelos con mango de madera y fibra de vidrio bimaterial ergonómico.
- Gran fiabilidad y resistencia.



Maceta mango madera

Código	Peso	Referencia	
26941	2Kg	MM2	6



Maza 900mm mango madera

Código	Peso	Referencia	
26942	5Kg	MM900-5KG	1

Mazas de goma

- Modelos con diferentes durezas.
- Maza color negro para trabajos donde no se puede emplear cabeza de acero.
- Cabeza blanca especial para alicatar. No marca ni daña las superficies.
- Cabeza mixta para ambos tipos de trabajos.



Maza de goma mango de madera, 500g

Código	Acabado	Referencia	
24929	Negro	MGN500	6
24930	Blanco	MGB500	6
26647	Blanco-negro	MGN-B500	6

Percusión y corte

Cortafíos y punteros

- Acero forjado endurecido.
- Mango ergonómico.
- Protección de mano para un uso seguro.



Cortafíos con protección

Código	Medida	Referencia	
24928	300x19x25mm	CF300	6



Puntero con protección

Código	Medida	Referencia	
26648	300x19mm	PT300	6



Cortafío

Código	Medida	Referencia	
27143	250x25mm	CFN-250	6
27144	300x25mm	CFN-300	6

Alcotanas y picolas

- Cabeza de aleación de acero forjado de gran dureza.
- Modelos con mango de madera y fibra de vidrio bimaternal.
- Gran fiabilidad y resistencia.



Alcotana mango fibra de vidrio. 290x41,5mm

Código	Peso	Referencia	
24164	590g	A-MFV	6



Alcotana picola mango madera

Código	Peso	Referencia	
26940	650g	A-MM	6



Herramienta de fijación





Sargentos y pinzas

Sargentos

- Modelos con husillo y semiautomáticos.
- Gran resistencia y durabilidad.
- Variedad de medidas para usos específicos.

Sargento mango bimaterral

Código	Medida	Referencia	
25311	50x100mm	SGB-50100	50
25312	50x150mm	SGB-50150	50
25313	50x200mm	SGB-50200	50
25314	50x250mm	SGB-50250	50
25315	50x300mm	SGB-50300	50
25316	80x200mm	SGB-80200	25
25317	80x300mm	SGB-80300	25
25318	80x400mm	SGB-80400	25
25319	80x500mm	SGB-80500	20

Código	Medida	Referencia	
25320	120x300mm	SGB-120300	10
25321	120x400mm	SGB-120400	10
25322	120x500mm	SGB-120500	10
25323	120x600mm	SGB-120600	10
25324	120x800mm	SGB-120800	8
25325	120x1000mm	SGB-1201000	8
25326	120x1200mm	SGB-1201200	6
25327	120x1500mm	SGB-1201500	6



Sargento de carpintero

Código	Medida	Referencia	
22465	120x500mm	SGC120500	10
22466	120x800mm	SGC120800	10
22467	120x1500mm	SGC1291500	6



Sargento rápido, alcance máximo 63mm y reversible

Código	Medida	Referencia	
24677	150mm	SRR2-6	12
24678	300mm	SRR2-12	6



Sargento rápido, alcance máximo 85mm y reversible

Código	Medida	Referencia	
24675	150mm	SRR1-6	6
24676	300mm	SRR1-12	6



Pinzas

- Modelos de nylon y metálica.
- Resorte de gran resistencia.
- Puntas protegidas para no dañar las superficies.

Pinza metálica con asa y punta de goma

Código	Medida	Referencia	
22452	100mm	PMT100	200
22453	150mm	PMT150	120
22454	225mm	PMT225	60



Pinza de nylon

Código	Medida	Referencia	
22449	100mm	PNY100	200
22450	150mm	PNY150	200
22451	225mm	PNY225	120





Mecanismo a una mano



Boquilla giratoria cuatro posiciones



Mango expulsa vástago



Remachadoras y grapadoras

Remachadoras

- Remachadoras, una y dos manos.
- Mangos ergonómicos.
- Para distintas medidas de remaches.
- Gran resistencia y durabilidad.

Remachadora, una mano. Boquilla giratoria 2,4 - 3,2 - 4,0 - 4,8

Código	Medida	Referencia	
26599	247mm	REM-1M	6



Boquillas intercambiables



Bote recoge vástagos



Mecanismo dos manos

Remachadora, dos manos. Boquilla intercambiable 3,2-4,0-4,8-6,0-6,4

Código	Medida	Referencia	
26600	320mm	REM-2M	1

Grapadoras

- Modelos con husillo y semiautomáticos.
- Gran resistencia y durabilidad.
- Variedad de medidas para usos específicos.



Grapadora metálica 53/23/13. 30% menos de esfuerzo

Código	Acabado	Referencia	
27882	Negro-plata	GRA02-PRE	6



Carga inferior



3 medidas de grapa



Grapado potente



Grapadora metálica compacta 53/23

Código	Acabado	Referencia	
27883	Azul-plata	GRA03	6



Carga trasera



2 medidas de grapa



Diseño compacto



Herramienta de aplicación

Pistolas

Pistolas para cartuchos

- Para diferentes aplicaciones.
- Mangos ergonómicos.
- Gran resistencia, fabricación bajo estándares de calidad.



Pistola aplicadora de cartuchos
Cuerpo de acero 1,2mm. Mango aluminio

Código	Acabado	Referencia	
25278	Rojo/negro	PS002	24



Pistola aplicadora de cartuchos reforzada
Mango aluminio

Código	Acabado	Referencia	
26381	Rojo/negro	PS007	12



Pistola reforzada



Pistola aplicadora de cartuchos reforzada
Mango aluminio

Código	Acabado	Referencia	
25173	Rojo/negro	PS008	12



Pistola reforzada



Pistola aplicadora de cartuchos
Cuerpo de acero 1mm

Código	Acabado	Referencia	
25281	Negro	PS004	24



Pistola aplicadora de cartuchos
Cuerpo de acero 1,2mm

Código	Acabado	Referencia	
25282	Cromado	PS005	24
25283	Naranja	PS006	24



Pistola aplicadora de cartuchos
Esqueleto acero 2mm

Código	Acabado	Referencia	
25277	Naranja	PS001	24



Fácil carga
roscando tuerca
de aluminio



Varilla y leva
reforzadas



Pistola aplicadora de mortero reforzada
Cuerpo de aluminio 1,3mm

Código	Acabado	Referencia	
25279	Alum./negro	PS003	6

Pistolas para mortero

- Cuerpo aluminio.
- Mango aluminio ergonómico.
- Fácil carga, mediante enroscado de la tuerca de aluminio.
- Pistola de alta potencia, para fluidos de mayor densidad.
- Materiales de calidad y gran resistecia.



Pistolas para espuma de poliuretano

- Para aplicar espuma de poliuretano de forma precisa y estable.
- Ligeras y manejables.
- Mangos ergonómicos.
- Flujo regulable en todos los modelos.
- Resistencia y durabilidad.

Pistola metálica poliuretano, aguja acero inox.
Cuerpo zamak. Regulable con una mano

Código	Acabado	Referencia	
27132	Gris/rojo	PPA03	1



Aguja INOX



Regulación con una mano

Pistola metálica aleación alu. Recub. Teflón
Regulable con una mano

Código	Acabado	Referencia	
27133	Negro/rojo	PPA04	1



Aguja TEFLÓN



Regulación con una mano

Pistola poliuretano, aguja acero inox.
Cuerpo zamak níquelado

Código	Acabado	Referencia	
26029	Azul	PPA01	1



Aguja INOX

Pistola poliuretano, aguja y cánula de acero inox.
Cuerpo polipropileno, cubierta de teflón

Código	Acabado	Referencia	
24835	Negro/verde	PPA02	1



Aguja INOX+TEFLÓN



Pistola termofusible

- Versátil y rápida para diferentes aplicaciones.
- Sistema calentamiento eléctrico 3-5 min.
- Para barras de cola termofusible.
- Almohadilla antideslizante en el mango.

80 W  Ø 11mm

Pistola de cola termofusible

Código	Acabado	Referencia	
24924	Azul	PPB-80	12

Accesorios para anclaje químico

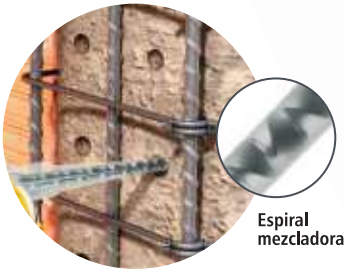
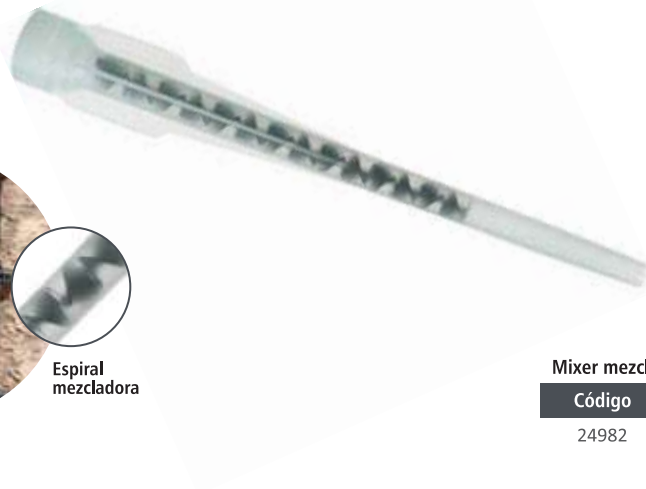

Espiral mezcladora

Mixer mezclador

- Mixer con espiral interior que realiza la mezcla de los componentes químicos.
- Color transparente.
- Válida para botes tanto de 300ml. como de 410ml.

Mixer mezclador para taco químico

Código	Acabado	Referencia	
24982	Blanco	N05/AQ/MX	1000

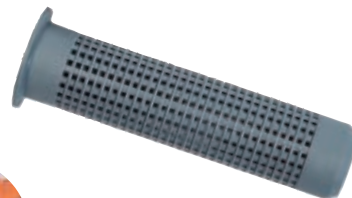

Ahorro de material y aumento de adherencia

Tamiz nylon

- Rejilla del tamiz ideal para tacos químicos, resinas y morteros de cemento de inyección que garantiza su bajo consumo y fijación.
- Versátil sistema de fijación para mampostería de piedra perforada.
- Disponible M6/M8/M10.

Tamiz de nylon para taco químico. M6/M8/M10

Código	Medida	Referencia	
24983	12x80mm	N05/AQ/TN	10
24984	16x85mm	N05/AQ/TN	10
24985	16x130mm	N05/AQ/TN	10

SOLDADURA

Máscaras, pinzas, protectores de pantalla... accesorios de calidad para usar con cualquier equipo, con electrodos, TIG... Ferrotech ofrece la mejor equipamiento para trabajos de soldadura.



Accesorios para soldar	57
Máscaras de soldar	57
Pinzas para soldar	58



Accesorios para soldar

Máscaras y filtros protectores

- Las máscaras Ferrotech permiten filtrar la luz y proteger la vista de los soldadores de los rayos ultravioleta y de los rayos infrarrojos que se generan durante todo el proceso de soldadura.

Máscara soldador autom. UV-DIN16 célula solar, batería de litio y 2 arcos sensores.

Código	Medida	Referencia	
24841	92-42mm	MSA01	1

- Área de visión 92x42mm.
- Protección UV/IR DIN 16.
- Tamaño del cartucho 110x90x9mm.
- Cabeza de aleación de acero forjado de gran dureza.
- Encendido/Apagado automático.
- Célula solar y batería de litio.
- Control de sensibilidad mediante regulación exterior.



Máscara soldador autom. UV-DIN16 célula solar, batería de litio y 4 arcos sensores independientes.

Código	Medida	Referencia	
24993	98-43mm	MSA02	1

- Área de visión 100x50mm.
- Protección UV/IR DIN 16.
- Tamaño del cartucho 110x90x9mm.
- Para soldadura y amolienda.
- Célula solar y batería de litio.
- Encendido/Apagado automático.
- Célula solar y batería de litio.
- Control de sensibilidad mediante regulación exterior.



Protector de pantalla p/máscara de soldar MSA02

Código	Medida	Referencia	
24994	116-104mm	P-MSA02	5

Cubrefiltros de policarbonato para protección de pantallas de soldadura, permitiendo una mayor duración de los filtros.

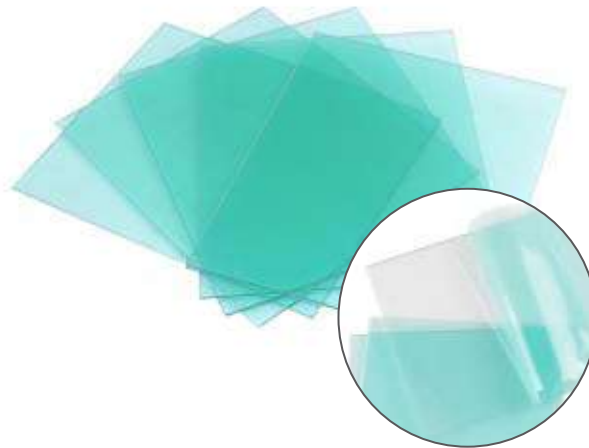

Pinzas para soldar y electrodos

Pinzas de masa y portaelectrodos

- Ferrotech ofrece pinzas de masa y pinzas portaelectrodos universales, para utilizar con cualquier tipo de máquina para soldar.

Pinza de masa soldadura Clip 300A

Código	Medida	Referencia	
21039	170-80mm	PINZA-M001	12

Pinza de masa para soldar universal, válida para todo tipo de máquinas de soldaduras.



Pinza portaelectrodo 300A

Código	Medida	Referencia	
21040	225x35x70mm	PINZA-E001	1

Pinza portaelectrodos para las máquinas de soldar con electrodos.



Electrodo de rutilo E6013. 60-85A

Código	Medida	Referencia	
20514	2,5x350mm	RUTIFIX	145
20515	3,2x350mm	RUTIFIX	95
20516	4,0x350mm	RUTIFIX	102

Electrodos

- Para soldadura AC / DC con corrientes de 40 - 70 a. permite soldar en todas las posiciones. Cumple con las regulaciones E6013.



ACCESORIOS Y CONSUMIBLES

Ferrotech cuenta con una gran gama de consumibles y accesorios para maquinaria electroportátil. Brocas y coronas multiusos, discos de corte y abrasión, todo tipo de accesorios para corte y desbaste... ofreciendo soluciones para distintas tareas profesionales, con unos altos estándares de calidad en cada uno de sus productos.

02



Perforación

60

Brocas y extractores de tornillos

60

Corona perforadora multiuso

66

Corte y abrasión

67

Discos de corte

67

Discos abrasivos

70

Cuchillos, cepillo eléctrico

71

Lijas para lijadora electroportátil

72

Cepillos de alambre

74



Perforación

Brocas y extractores de tornillos

Brocas para metal

- Diferentes gamas de brocas para la perforación de metal.
- Estándar HSS, 5% cobalto HSS y broca escalonada.
- Norma DIN338.



Broca helicoidal rectific. estándar HSS-G DIN338. Acero rápido rectificado

Código	Medida	Referencia	
25506	1x34mm	HSSG-338N	10
25507	1,5x40mm	HSSG-338N	10
25508	2x49mm	HSSG-338N	10
25509	2,5x57mm	HSSG-338N	10
25510	3x61mm	HSSG-338N	10
25511	3,5x70mm	HSSG-338N	10
25512	4x75mm	HSSG-338N	10
25513	4,5x80mm	HSSG-338N	10
25514	5x86mm	HSSG-338N	10
25515	5,5x93mm	HSSG-338N	10
25516	6x93mm	HSSG-338N	10
25517	6,5x101mm	HSSG-338N	10
25518	7x109mm	HSSG-338N	10
25519	7,5x109mm	HSSG-338N	10
25520	8x117mm	HSSG-338N	10
25521	8,5x117mm	HSSG-338N	5
25522	9x125mm	HSSG-338N	5
25523	9,5x125mm	HSSG-338N	5
25524	10x133mm	HSSG-338N	5
25525	10,5x133mm	HSSG-338N	5
25526	11x142mm	HSSG-338N	5
25527	11,5x142mm	HSSG-338N	5
25528	12x151mm	HSSG-338N	5
25529	12,5x151mm	HSSG-338N	5
25530	13x151mm	HSSG-338N	5



Broca helicoidal rectific. 5% cobalto HSS-CO DIN338. Acero cobalto 5%

Código	Medida	Referencia	
25566	1x34mm	HSSCO-338	10
25630	1,5x49mm	HSSCO-338	10
25567	2x49mm	HSSCO-338	10
24507	2,25x53mm	HSSCO-338	10
25631	2,50x57mm	HSSCO-338	10
24508	2,75x61mm	HSSCO-338	10
25568	3x61mm	HSSCO-338	10
24509	3,25x65mm	HSSCO-338	10
25632	3,5x70mm	HSSCO-338	10
24510	3,75x70mm	HSSCO-338	10
25569	4x75mm	HSSCO-338	10
24511	4,25x75mm	HSSCO-338	10
25633	4,50x80mm	HSSCO-338	10
24512	4,75x80mm	HSSCO-338	10
25570	5x86mm	HSSCO-338	10
24513	5,25x86mm	HSSCO-338	10
25634	5,5x93mm	HSSCO-338	10
24514	5,75x93mm	HSSCO-338	10
25571	6x93mm	HSSCO-338	10
25635	6,5x101mm	HSSCO-338	10
25572	7x109mm	HSSCO-338	10
25636	7,5x109mm	HSSCO-338	10
25573	8x117mm	HSSCO-338	10
25637	8,5x117mm	HSSCO-338	5
25574	9x125mm	HSSCO-338	5
25638	9,5x125mm	HSSCO-338	5
25575	10x133mm	HSSCO-338	5
25576	11x142mm	HSSCO-338	5
25577	12x151mm	HSSCO-338	5
25578	13x151mm	HSSCO-338	5

Broca escalonada

Código	Medida	Referencia	
27136	4-20mm	BRES-R4-20	10
27137	4-32mm	BRES-R4-32	10



Canal recto



Acero aleado, acero inox y fundición

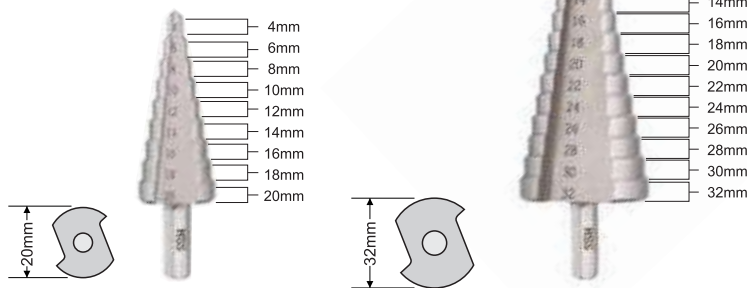

Set 5 extractores de tornillos

Código	Medida	Referencia	
27135	M3/M18	5EXTR-M3/M18	12



Acero alta resistencia CROMO MOLIBDENO



Extractores de tornillos

- El set de 5 extractores se presenta en un práctico estuche.
- Fabricados en acero al cromo molibdeno de especial dureza y calidad.
- M3/M6, M6/M8, M8/M11, M11/M14, M14/M18.

Broca superior hormigón DIN 8039 ISO 5 (Serie corta)

Código	Medida	Referencia	
25803	3x60mm	SH-DIN8039	1
25804	4x75mm	SH-DIN8039	1
25805	5x85mm	SH-DIN8039	1
25806	6x100mm	SH-DIN8039	1
25807	7x100mm	SH-DIN8039	1
25808	8x120mm	SH-DIN8039	1
25809	9x120mm	SH-DIN8039	1
25810	10x120mm	SH-DIN8039	1
25811	11x150mm	SH-DIN8039	1
25812	12x150mm	SH-DIN8039	1
25813	13x150mm	SH-DIN8039	1
25814	14x150mm	SH-DIN8039	1
25815	15x150mm	SH-DIN8039	1
25816	16x150mm	SH-DIN8039	1
25817	18x160mm	SH-DIN8039	1
25818	20x160mm	SH-DIN8039	1

Broca superior hormigón DIN 8039 ISO 5 (Serie media)

Código	Medida	Referencia	
25819	5x150mm	SH-DIN8039	1
25820	6x150mm	SH-DIN8039	1
25821	8x200mm	SH-DIN8039	1
25822	10x200mm	SH-DIN8039	1
25823	12x200mm	SH-DIN8039	1

Broca superior hormigón DIN 8039 ISO 5 (Serie larga)

Código	Medida	Referencia	
25824	6x400mm	SH-DIN8039	1
25825	8x400mm	SH-DIN8039	1
25826	10x400mm	SH-DIN8039	1
25827	12x400mm	SH-DIN8039	1
25828	14x400mm	SH-DIN8039	1
25829	16x400mm	SH-DIN8039	1
25830	18x400mm	SH-DIN8039	1
25831	20x400mm	SH-DIN8039	1

Brocas para muro, piedra, granito...

- Brocas para muros, materiales extraduros y multimaterial.
- Máxima calidad.
- DIN8039, ISO 5, superior hormigón.



Muro



Hormigón



Piedra y granito



Broca helicoidal para cerámica, gres porcelánico y granito, profesional (Serie corta)

Código	Medida	Referencia	
20426	4x75mm	B-PORCEL	1
20427	5x85mm	B-PORCEL	1
20428	6x100mm	B-PORCEL	1
20429	8x120mm	B-PORCEL	1
20430	10x120mm	B-PORCEL	1

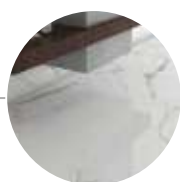

Especial materiales extraduros

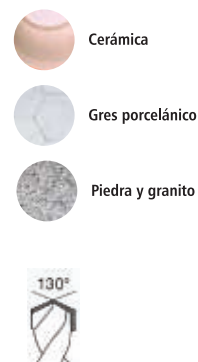

Broca helicoidal multiusos para pladur, ladrillo y aluminio, profesional (Serie corta)

Código	Medida	Referencia	
20431	4x75mm	B-MULT	1
20432	5x85mm	B-MULT	1
20433	6x100mm	B-MULT	1
20434	8x120mm	B-MULT	1
20435	10x120mm	B-MULT	1

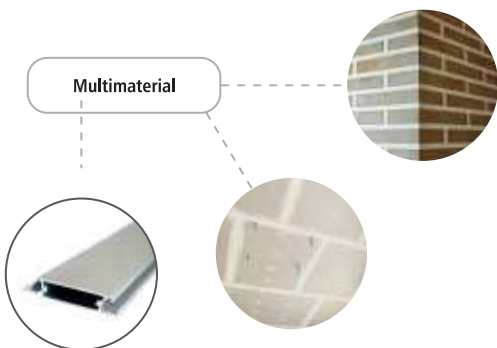

Multimaterial



Portabrocas automático

Código	Medida	Referencia	
25076	(1/2) 2-13mm	PORT-02	1
25072	(3/8) 2-13mm	PORT-01	1



Broca para martillo SDS-PLUS

Código	Medida	Referencia	
25582	6x110mm	SDS-PLUS	1
25583	6x160mm	SDS-PLUS	1
25584	6x210mm	SDS-PLUS	1
25586	7x160mm	SDS-PLUS	1
25587	8x110mm	SDS-PLUS	1
25588	8x160mm	SDS-PLUS	1
25589	8x210mm	SDS-PLUS	1
25590	8x260mm	SDS-PLUS	1
25591	8x460mm	SDS-PLUS	1
25592	9x160mm	SDS-PLUS	1
25594	10x110mm	SDS-PLUS	1
25595	10x160mm	SDS-PLUS	1
25596	10x210mm	SDS-PLUS	1
25597	10x260mm	SDS-PLUS	1
25598	10x310mm	SDS-PLUS	1
25602	12x160mm	SDS-PLUS	1
25603	12x210mm	SDS-PLUS	1
25604	12x260mm	SDS-PLUS	1
25605	12x310mm	SDS-PLUS	1
25606	12x460mm	SDS-PLUS	1
25607	14x160mm	SDS-PLUS	1
25608	14x210mm	SDS-PLUS	1
25609	14x260mm	SDS-PLUS	1
25610	14x310mm	SDS-PLUS	1
25611	14x460mm	SDS-PLUS	1
25612	16x210mm	SDS-PLUS	1
25613	16x250mm	SDS-PLUS	1
25614	16x300mm	SDS-PLUS	1
25615	16x450mm	SDS-PLUS	1
25616	18x200mm	SDS-PLUS	1
25617	18x250mm	SDS-PLUS	1
25618	18x300mm	SDS-PLUS	1
25619	18x450mm	SDS-PLUS	1
25620	20x200mm	SDS-PLUS	1
25621	20x300mm	SDS-PLUS	1
25622	20x450mm	SDS-PLUS	1
25623	22x250mm	SDS-PLUS	1
25624	22x450mm	SDS-PLUS	1
25625	24x250mm	SDS-PLUS	1
25626	24x450mm	SDS-PLUS	1
25627	26x450mm	SDS-PLUS	1



SDS-PLUS

- Anclaje SDS-PLUS, más rápido y con mayor sujeción.
- Mayor vida útil, velocidad de perforación, menos polvo y menos vibraciones.



Puntero para martillo SDS-PLUS

Código	Medida	Referencia	
25842	Ø14x250mm	P/SDS-PLUS	1



Cinzel para martillo SDS-PLUS

Código	Medida	Referencia	
25843	Ø14x250x20mm	CP/SDS-PLUS	1



Cinzel para martillo SDS-MAX

Código	Medida	Referencia	
25846	Ø18x400x25mm	CP/SDS-MAX	1



SDS-PLUS / SDS-MAX

- Anclaje SDS-PLUS y SDS-MAX, más rápido y con mayor sujeción.
- Mayor vida útil, velocidad de perforación, menos polvo y menos vibraciones.



Set de brocas para hormigón y acero

- Prácticos estuches con selección de brocas con las medidas más utilizadas para hormigón y acero.

Set 6 brocas hormigón superior DIN 8039

Código	Medida	Referencia	
27318	6 a 16mm	6SH-DIN8039	10



6 - 8 - 10 - 12 - 14 - 16mm



Muro



Hormigón



Piedra y granito



Set 5 brocas para hormigón SH-8039 Ø4-5-6-8-10mm

Código	Medida	Referencia	
26531	4 a 10mm	SET-5/SH8039	25



4 - 5 - 6 - 8 - 10mm



Muro



Hormigón



Piedra y granito



Set 13 brocas para acero HSS-G desde Ø2 a 8mm

Código	Medida	Referencia	
26532	2 a 8mm	SET-13/HSS-G	20



2 - 2,5 - 3 - 3,5 - 4 - 4,5 - 5 - 5,5 - 6 - 6,5 - 7 - 7,5 - 8mm



Acero aleado, acero inox y fundición



R=800 N/mm2



Broca helicoidal para madera profesional (Serie corta)

Código	Medida	Referencia	
25645	3x60mm	HSS-7487	1
25646	4x75mm	HSS-7487	1
25647	5x85mm	HSS-7487	1
25648	6x92mm	HSS-7487	1
25649	7x100mm	HSS-7487	1
25650	8x115mm	HSS-7487	1
25651	9x116mm	HSS-7487	1
25652	10x130mm	HSS-7487	1
25653	11x142mm	HSS-7487	1
25654	12x150mm	HSS-7487	1
25655	13x151mm	HSS-7487	1
25656	14x160mm	HSS-7487	1
25657	15x169mm	HSS-7487	1

(Serie larga)

Código	Medida	Referencia	
25668	6x400mm	HSS-7487	1
25669	8x400mm	HSS-7487	1
25670	10x400mm	HSS-7487	1
25671	12x400mm	HSS-7487	1
25672	14x400mm	HSS-7487	1
25673	16x400mm	HSS-7487	1
25674	18x400mm	HSS-7487	1

Broca plana para madera W.S.

Código	Medida	Referencia	
25677	6mm	W.S.	1
25678	8mm	W.S.	1
25680	10mm	W.S.	1
25681	12mm	W.S.	1
25682	13mm	W.S.	1
25683	14mm	W.S.	1
25684	15mm	W.S.	1
25685	16mm	W.S.	1
25686	18mm	W.S.	1
25687	19mm	W.S.	1
25688	20mm	W.S.	1
25689	22mm	W.S.	1
25690	24mm	W.S.	1
25691	25mm	W.S.	1
25692	26mm	W.S.	1
25693	28mm	W.S.	1
25694	30mm	W.S.	1
25695	32mm	W.S.	1
25696	34mm	W.S.	1
25697	35mm	W.S.	1
25698	36mm	W.S.	1
25699	38mm	W.S.	1
25700	40mm	W.S.	1

Brocas para madera

- Brocas helicoidal y plana para madera.
- Punta centrada y bordes afilados para cortes precisos y más rápidos.



Madera



Madera



Corona perforadora multiuso

Corona perforadora bimetalica

- Para perforar múltiples materiales.
- Fabricadas en metal HSS.
- Gran dureza y alta resistencia al calor.

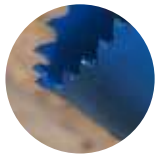

Dientes resistentes y corte preciso



Orificio para expulsión rápida del material

- Madera
- PVC
- Pladur
- Metal

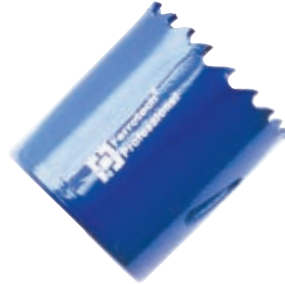

Corona perforadora bimetalica multiuso HSS

Código	Medida	Referencia	
25701	14x48mm	HSS-CB	1
25975	16x48mm	HSS-CB	1
25702	17x48mm	HSS-CB	1
25703	19x48mm	HSS-CB	1
25704	20x48mm	HSS-CB	1
25976	22x48mm	HSS-CB	1
25705	25x48mm	HSS-CB	1
25706	27x48mm	HSS-CB	1
25707	30x48mm	HSS-CB	1
25708	32x48mm	HSS-CB	1
25709	35x48mm	HSS-CB	1
25977	38x48mm	HSS-CB	1
25710	40x48mm	HSS-CB	1
25711	44x48mm	HSS-CB	1
25712	46x48mm	HSS-CB	1
25978	48x48mm	HSS-CB	1
25713	51x48mm	HSS-CB	1
25714	54x48mm	HSS-CB	1
25715	57x48mm	HSS-CB	1
25716	60x48mm	HSS-CB	1
25717	64x48mm	HSS-CB	1
25979	67x48mm	HSS-CB	1
25718	70x48mm	HSS-CB	1
25980	73x48mm	HSS-CB	1
25981	75x48mm	HSS-CB	1
25719	76x48mm	HSS-CB	1
25720	89x48mm	HSS-CB	1
25721	92x48mm	HSS-CB	1
25722	95x48mm	HSS-CB	1
25723	98x48mm	HSS-CB	1
25724	102x48mm	HSS-CB	1
25725	105x48mm	HSS-CB	1
25726	108x48mm	HSS-CB	1
25727	111x48mm	HSS-CB	1
25728	114x48mm	HSS-CB	1
25729	121x48mm	HSS-CB	1
25730	127x48mm	HSS-CB	1
25731	140x48mm	HSS-CB	1
25732	152x48mm	HSS-CB	1

9 SET



Set 9 coronas M42 HSS de Ø19 a 64mm, 2 adaptadores y broca centradora

Código	Medida	Referencia	
25109	Ø19 a 64mm	HSS-CB-9	1



Husillo para corona 14-30mm

Código	Medida	Referencia	
25733	14-30mm	HU-14/30	1

13 SET



Set 13 coronas M42 HSS de Ø19 a 76mm, 2 adaptadores y broca centradora

Código	Medida	Referencia	
25110	Ø19 a 76mm	HSS-CB-13	1



Husillo para corona 32-152mm

Código	Medida	Referencia	
25734	32-152mm	HU-32/152	1



Corte y abrasión

Discos de diamante

- Diseñados para ofrecer la máxima velocidad, vida útil y manipulación en tareas de corte de hormigón y otros minerales.
- Calidad comprobada EN 13236:2019.

Disco diamante ESTÁNDAR. General obra



Código	Medida	Referencia	
24473	115x8x1.4mm	DD-S	1
24475	230x8x1.8mm	DD-S	1



Ladrillo



Hormigón

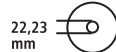

22,23
mm



Piedra



Disco diamante PREMIUM. General obra



Código	Medida	Referencia	
24482	115x10x2mm	NDD-P	1
24484	230x8x1.8mm	NDD-P	1



Ladrillo



Hormigón

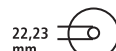

22,23
mm



Granito



Terrazo



Pizarra



Discos de corte



Disco diamante GRANITO. General obra



Código	Medida	Referencia	
24490	115x8x1.4mm	DD-G	1
24493	230x8x1.8mm	DD-G	1

- Ladrillo
- Hormigón
- Granito
- Terrazo
- Pizarra

22,23 mm

CALIDAD COMPROBADA
EN 13236:2019



Especial materiales extraduros

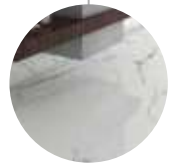

Disco diamante TURBO-PLUS. General obra



Código	Medida	Referencia	
27270	115x10x2mm	DD-G/TB	1
27271	230x10x2.6mm	DD-G/TB	1

- Ladrillo
- Hormigón
- Piedra

22,23 mm

TURBO-PLUS
MÁXIMA RAPIDEZ DE CORTE

CALIDAD COMPROBADA
EN 13236:2019



Disco diamante TURBO EXTRAFINO PORCELÁNICO



Código	Medida	Referencia	
24488	115x3x1.2mm	DD-TPG	1

- Porcelanato
- Ferrogres
- Granito
- Terrazo
- Pizarra

22,23 mm

TURBO
RAPIDEZ DE CORTE

CALIDAD COMPROBADA
EN 13236:2019



Especial materiales extraduros

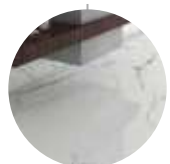



Disco MULTIMATERIAL tungsteno



Código	Medida	Referencia	
24490	115x8x1.4mm	DD-G	1

Ladrillo

Pladur

PVC

Madera

22,23 mm

Multimaterial



Dientes **ATB** para cortar madera. Filo de dientes en oblicuo y la dirección de cada uno alternada de izquierda a derecha para evitar que la madera se astille.



Dientes **TP**. Diente plano seguido de otro trapezoidal para romper la viruta en 3 partes y, de esta forma, que el acabado sea perfecto.



ALTA CALIDAD
Menos ruido
Menos calentamiento
Menos vibraciones

Las ranuras de expansión son las responsables de que el borde del disco tenga un menor calentamiento durante el corte, sea mucho mejor y, además, que los dientes tengan una mayor vida útil, la plancha no se tuerza y haya mayor resistencia a la torsión.

Discos de widia

- Dientes ATB y TP para corte distintos de distintos materiales.
- Ranuras de expansión.
- Calidad comprobada EN 847-1:2017.

Disco widia corte madera. Diente ATB

Código	Medida	Referencia	T. Diente	N. Dientes	
27621	Ø 300mm	DWC300/Z48	ATB	Z-48	1
27618	Ø 300mm	DWC300/Z72	ATB	Z-72	1
27619	Ø 305mm	DWC305/Z96	ATB	Z-96	1



Madera



Aglomerados
Tableros
Contrachapados



Disco widia corte aluminio. Diente TP

Código	Medida	Referencia	T. Diente	N. Dientes	
27622	Ø 300mm	DWC300/Z96	TP	Z-96	1



Aluminio



Panel sandwich
Laminados
Contrachapado



Discos abrasivos

Disco abrasivo corte para hierro

Código	Medida	Tipo	Referencia	
23752	115x3,0x22,23mm	A 24 R-BF	DA-HIE	50
23754	125x3,0x22,23mm	A 24 R-BF	DA-HIE	50
23758	230x3,2x22,23mm	A 24 R-BF	DA-HIE	25

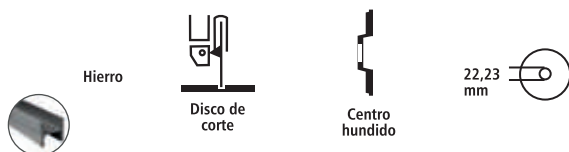

Disco abrasivo desbaste para hierro

Código	Medida	Tipo	Referencia	
23762	115x6,4x22,23mm	A 24 S-BF	DA-HIE-P FDS	50
23764	125x6,4x22,23mm	A 24 R-BF	DA-HIE-P FDS	50
23768	230x7,0x22,23mm	A 24 S-BF	DA-HIE-P FDS	25

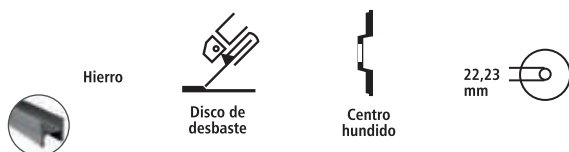

Disco abrasivo corte para hierro. Máquina fija

Código	Medida	Tipo	Referencia	
23760	305x3,5x22,23mm	A 30 R-BF	DA-HIE	25



Disco abrasivo corte para piedra

Código	Medida	Tipo	Referencia	
23769	115x3,0x22,23mm	C 36 R-BF	DA-PIE	50
23770	125x3,0x22,23mm	C 36 R-BF	DA-PIE	50
23772	230x3,2x22,23mm	C 36 R-BF	DA-PIE	25



Discos para corte y desbaste

- Discos abrasivos para hierro, piedra, inox...
- Calidad comprobada FEPA-EN12413.



Disco abrasivo corte para acero inoxidable

Código	Medida	Tipo	Referencia	
23773	115x1,0x22,23mm	A 36 S-BF	DA-INOX	100
23774	125x1,2x22,23mm	A 36 S-BF	DA-INOX	100
23776	230x2,0x22,23mm	A 36 S-BF	DA-INOX	60

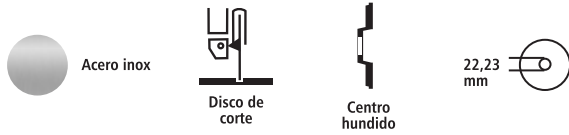

Disco abrasivo corte para acero inoxidable. PLUS

Código	Medida	Tipo	Referencia	
24001	115x1,0x22,23mm	A 60 T-BF	DA-INOX-P	100

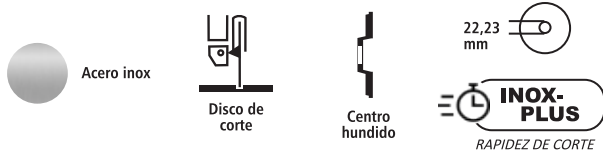

Discos de lámina zirconio

Código	Medida	Grano	Referencia	
26325	115x22,23mm	40	DL Z/29	10
26326	115x22,23mm	60	DL Z/29	10
26327	115x22,23mm	80	DL Z/29	10
26328	115x22,23mm	120	DL Z/29	10
26545	125x22,23mm	40	DL Z/29	10
26546	125x22,23mm	60	DL Z/29	10
26547	125x22,23mm	80	DL Z/29	10
26548	125x22,23mm	120	DL Z/29	10



Discos de lámina zirconio

- Para desbaste, terminación y limpieza de superficies de acero inox.
- Calidad comprobada EN 13236:2019.

Cuchillas, cepillo eléctrico

Cuchillas carburo de tungsteno

Código	Medida	Referencia	
24991	82x5,5x1,1mm	CCT/82	10
24992	78x5,5x1,1mm	CCT/78	10



Cuchillas de carburo

- Cuchillas de cepilladora resistentes y duraderas.
- Fabricadas con carburo de tungsteno.
- Compatibles con todas las marcas.

Makita, Bosch, Stayer, Metabo, Milwaukee, Dewalt, Ferrotech, Virutex...



Lijas para lijadora electroportátil



Para madera y uso general

Compatibles con lijadoras de todas las marcas: Bosch, Makita, Dewalt, Milwaukee, Hitachi, Metabo, Black+decker...

Lijas para lijadoras orbitales

- Repuesto de lijas para maquinaria electroportátil.
- Uso eficaz en distintas superficies y materiales.
- Compatibles con todas las marcas.

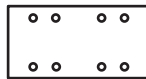

Blíster 10 udes. Lija rectangular 93x185mm

Código	Medida	Grano	Referencia	
27546	93x185mm	40	LR-93x185/40	130
27547	93x185mm	60	LR-T93x185/60	130
27548	93x185mm	80	LR-T93x185/80	130

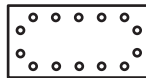

Blíster 5 udes. Lija rectangular 115x230mm

Código	Medida	Grano	Referencia	
27549	115x230mm	40	LR-115x230/40	150
27550	115x230mm	60	LR-115x230/60	170
27551	115x230mm	80	LR-115x230/80	170



Blíster 5 udes. Lija triangular 93mm

Código	Medida	Grano	Referencia	
27556	93mm	40	LT-93/40	400
27557	93mm	60	LT-93/60	400
27558	93mm	80	LT-93/80	400
27555	93mm	120	LT-93/120	150



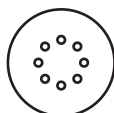

Blíster 5 udes. lija disco 125mm

Código	Medida	Grano	Referencia	
27560	125mm	40	LD-125/40	250
27561	125mm	60	LD-125/60	250
27562	125mm	80	LD-125/80	250

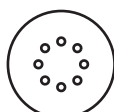

Blíster 5 udes. lija disco 150mm

Código	Medida	Grano	Referencia	
27563	150mm	40	LD-150/40	200
27564	150mm	60	LD-150/60	200
27565	150mm	80	LD-150/80	250



Blíster 5 udes. lija banda 75x533mm

Código	Medida	Grano	Referencia	
27570	75x533mm	40	LB-75x533/40	30
27571	75x533mm	60	LB-75x533/60	30
27572	75x533mm	80	LB-75x533/80	30
27573	75x533mm	120	LB-75x533/120	30



Blíster 5 udes. lija banda 76x457mm

Código	Medida	Grano	Referencia	
27566	76x457mm	40	LB-76x457/40	30
27567	76x457mm	60	LB-76x457/60	30
27568	76x457mm	80	LB-76x457/80	30
27569	76x457mm	120	LB-76x457/120	30

Cepillos de alambre

Cepillos de alambre para taladros

- Cepillos de alambre para acoplar a taladros eléctricos.
- Uso para la eliminación de óxido, lijado y pulido de superficies metálicas, metales no ferrosos, acero, madera y materiales huecos.



Cepillo de copa alambre ondulado M-14. Acero latonado

Código	Medida	Referencia	
24083	14x75mm	CCAO14	5
24084	14x85mm	CCAO14	5
24085	14x100mm	CCAO14	6
24086	14x125mm	CCAO14	6



Cepillo de copa alambre trenzado M-14. Acero templado

Código	Medida	Referencia	
24087	14x65mm	CCAT14	5
24088	14x100mm	CCAT14	5



Cepillo de copa alambre ondulado con vástago. Acero latonado

Código	Medida	Referencia	
24089	50mm	CCAO-V	5
24090	75mm	CCAO-V	5
24091	80mm	CCAO-V	5



Cepillo circular alambre ondulado con vástago. Acero latonado

Código	Medida	Referencia	
24092	50mm	CCIAO-V	12
24093	75mm	CCIAO-V	5
24094	100mm	CCIAO-V	5



Cepillo brocha con vástago alambre ondulado. Acero latonado

Código	Medida	Referencia	
24095	25mm	CBAO-V	10



Cepillo semicopa alambre ondulado M-14. Acero latonado

Código	Medida	Referencia	
24096	100mm	CSAO14	10
24097	125mm	CSAO14	10



Cepillo circular alambre trenzado Øint. 22,2mm. Acero templado

Código	Medida	Nudos	Referencia	
24754	Ø115mm	20	CCIAT22.2	5
24755	Ø125mm	20	CCIAT22.2	5
24756	Ø175mm	30	CCIAT22.2	5



Cepillo de copa nylon con vástago

Código	Medida	Referencia	
24101	50mm	CCN-V	5
24102	75mm	CCN-V	5



Cepillo circular de nylon con vástago

Código	Medida	Referencia	
24099	75mm	CCIN-V	5
24100	100mm	CCIN-V	5



CONSTRUCCIÓN

Descubre nuestra amplia gama de productos para la construcción. Llanas y talochas; paletas, paletines y espátulas; cubos y espuertas; mazas y macetas... y mucho más. Herramientas imprescindibles para obras o reformas al mejor precio y con la calidad profesional de Ferrotech.



Herramientas para yeso, cemento y mortero

77

Llanas y talochas	77
Paletas, paletines y espátulas	81
Cubos y espuertas	83
Suelo de goma	84

Herramientas de corte y percusión

85

Mazas y macetas	85
Cortafríos, punteros y alcotanas	86

Palas y carretillas

87

Palas	87
Carretillas	89

Mallas y señalización

91

Mallas	91
Cinta señalización	92

EPI

93

Calzado seguridad	93
-------------------	----



Herramientas para yeso, cemento y mortero

Llanas

- Para extender argamasa sobre paramentos planos y verticales; esto es, paredes, techos y suelos.
- Lisas y dentadas, en acero inoxidable o acero templado, con mango de madera, hierro y madera o ABS.

Llana de acero inoxidable con mango de madera

Código	Medida	Referencia	
24117	300x150mm	LLIM	6



Llana de acero templado con mango de madera

Código	Medida	Referencia	
24118	300x150mm	LLAM	6



Llana dentada de acero inoxidable con mango de madera

Código	Medida	Dentado	Referencia	
24119	300x150mm	6x6	LLIDM	6
24120	300x150mm	8x8	LLIDM	6
24121	300x150mm	10x10	LLIDM	6



Llanas y talochas

Llana media luna de acero inoxidable con mango de madera

Código	Medida	Referencia	
26863	300x150mm	LLIM-ML	6

**Llana de acero inoxidable con mango de ABS**

Código	Medida	Referencia	
27165	300x150mm	LLIP	6

**Llana de acero templado con mango de ABS**

Código	Medida	Referencia	
27166	300x150mm	LLAP	6

**Llana dentada de acero inoxidable con mango de ABS**

Código	Medida	Dentado	Referencia	
27167	300x150mm	6x6	LLIDP	6
27168	300x150mm	8x8	LLIDP	6
27169	300x150mm	10x10	LLIDP	6



Lana de acero inoxidable con mango de hierro y madera

Código	Medida	Referencia	
24122	280x120mm	LLIMH	6



Lana de acero inoxidable con mango de hierro y madera

Código	Medida	Referencia	
26939	280x120mm	LLIMB	6



Talochas

- Se utiliza para aplicar y allanar el mortero en una superficie, normalmente una pared o un muro.
- Con forma rectangular o terminada en punta, de plástico o base de esponja y base de goma esponja.

Talocha de plástico

Código	Medida	Referencia	
26444	235x180mm	LLPR	10



Talocha de plástico

Código	Medida	Referencia	
26443	265x140mm	LLPP	10



Talocha con base de esponja, mango poliuretano

Código	Medida	Referencia	
27145	280x140mm	T-PVC/ES	6



Esponja baja dens.
27mm

**Talocha con base de goma esponja, mango poliuretano**

Código	Medida	Referencia	
26956	280x140mm	TP/ES-280	6



Goma esponja
20mm

**Talocha de plástico. Mango madera**

Código	Medida	Referencia	
26945	270x180mm	TPR-MM	10



Paletas y paletines

- Para mezclar, batir, aplicar y recoger el mortero o cualquier otro tipo de argamasa, entre otros usos.
- Diferentes tipos, según sus terminaciones, y medidas.

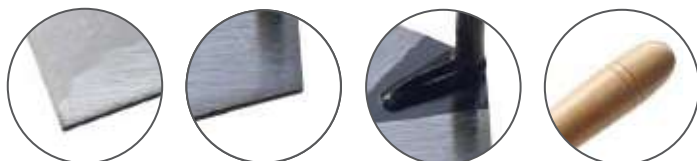

Alta calidad acero

Acero con tratamiento térmico, forjada en una sola pieza, soldadura irrompible, mango de madera de haya.

Paleta, mod. Catalán

Código	Medida	Referencia	
25176	150x106mm	PAL-01-150	6
25177	165x120mm	PAL-01-165	6
25178	170x120mm	PAL-01-170	6

Paleta, mod. Madrid

Código	Medida	Referencia	
25179	165x85mm	PAL-02-165	6
25180	190x105mm	PAL-02-190	6
25181	215x115mm	PAL-02-215	6

Paleta, mod. Norte

Código	Medida	Referencia	
25182	180x116mm	PAL-03-116	6
25183	180x130mm	PAL-03-130	6

Paleta, mod. Sevilla

Código	Medida	Referencia	
25184	190x114mm	PAL-04-190	6

Paletas, paletines y espátulas



Paleta, mod. Solador. Redondo

Código	Medida	Referencia	
25185	120x105mm	PAL-05-Red	6

**Paleta, mod. Solador. Recto**

Código	Medida	Referencia	
25186	125x105mm	PAL-05-Rec	6

**Paletín, mod. Norte**

Código	Medida	Referencia	
25187	140x80mm	PAL-06-140	6

**Paletín, mod. Laurel**

Código	Medida	Referencia	
25188	140x60mm	PAL-07-140	6

**Paletín, mod. Madrid**

Código	Medida	Referencia	
25189	140x80mm	PAL-08-140	6



Espátulas

- Amplio abanico de aplicaciones, con hojas flexibles para buenos resultados.
- Hoja de acero inoxidable, con mango de madera o bimaterial.

Espátula de acero inoxidable con mango de madera

Código	Medida	Referencia	
24103	30mm	EAIM	12
24104	40mm	EAIM	12
24105	50mm	EAIM	12
24106	60mm	EAIM	12
24107	70mm	EAIM	12
24108	80mm	EAIM	12
24109	100mm	EAIM	12
24837	125mm	EAIM	12
24838	150mm	EAIM	12



Espátula de acero inoxidable con mango bimaterial

Código	Medida	Referencia	
24110	30mm	EAIB	12
24111	40mm	EAIB	12
24112	50mm	EAIB	12
24113	60mm	EAIB	12
24114	70mm	EAIB	12
24115	80mm	EAIB	12
24116	100mm	EAIB	12



Cubos y espuelas de goma

- Para trabajos de albañilería y construcción.
- Muy flexible, resistente y fácil de trasladar. Con asa metálica (cubos) y de goma (espuelas).

Cubo goma pico. 11,5L

Código	Medida	Referencia	
27320	320x255mm	CU-GO11LPI	10



Ø sup. 320mm
Ø inf. 200mm

Alt. 255mm

1,9 Kg

Cubos y espuelas



Cubo de goma italiana. 10L

Código	Medida	Referencia	
25165	10l	CUBO-GOMA 01	10



Ø sup. 350mm
Ø inf. 225mm



Alt. 190mm



2 Kg



Espuerta goma. 12L

Código	Medida	Referencia	
27809	12l	ESP-GO12L	10



Ø sup. 400mm
Ø inf. 290mm



Alt. 140mm



1,6 Kg



Espuerta goma. 60L

Código	Medida	Referencia	
27808	60l	ESP-GO60L	10



Ø sup. 565mm
Ø inf. 365mm



Alt. 410mm



5,8 Kg



Suelo de goma

Pavimentos

- Color negro, distintos acabados de superficie.
- Se limpia muy fácilmente con productos no agresivos

Suelo de goma negro. 1,5g/cm³. 3MPA

10mm 

Código	Acabado	Referencia	Espesor	Ancho
20483	Liso	SGL-3	3mm	1,5m
20484	Liso	SGL-5	5mm	1,5m
20485	Círculos	SGC	3mm	1m
20486	Círculos	SGC	3mm	1,5m
20487	Estriberas	SGE	3mm	1m
20488	Estriberas	SGE	3mm	1,5m



LISO

CÍRCULOS

ESTRIBERAS



Herramientas de corte y percusión

Macetas y mazas

- Cabeza de aleación de acero forjado de gran dureza.
- Modelos con mango de madera y fibra de vidrio bimaternal ergonómico.
- Gran fiabilidad y resistencia.

Maceta mango fibra de vidrio

Código	Peso	Referencia	
26021	1,0kg	MFV1	6
26022	1,5kg	MFV1.5	6

Maceta mango madera

Código	Peso	Referencia	
26941	2Kg	MM2	6

Maza 900mm mango madera

Código	Peso	Referencia	
26942	5Kg	MM900-5KG	1

Mazas de goma

- Modelos con diferentes durezas.
- Maza color negro para trabajos donde no se puede emplear cabeza de acero.
- Cabeza blanca especial para alicatar. No marca ni daña las superficies.
- Cabeza mixta para ambos tipos de trabajos.

Maza de goma mango de madera, 500g

Código	Acabado	Referencia	
24929	Negro	MGN500	6
24930	Blanco	MGB500	6
26647	Blanco-negro	MGN-B500	6

Mazas y macetas



Cortafríos, punteros y alcotanas

Cortafríos y punteros

- Acero forjado endurecido.
- Mango ergonómico.
- Protección de mano para un uso seguro.

Cortafríos con protección

Código	Medida	Referencia	
24928	300x19x25mm	CF300	6

Puntero con protección

Código	Medida	Referencia	
26648	300x19mm	PT300	6

Cortafrío

Código	Medida	Referencia	
27143	250x25mm	CFN-250	6
27144	300x25mm	CFN-300	6

Alcotanas y picolas

- Cabeza de aleación de acero forjado de gran dureza.
- Modelos con mango de madera y fibra de vidrio bimaterial.
- Gran fiabilidad y resistencia.

Alcotana picola mango madera

Código	Peso	Referencia	
26940	650g	A-MM	6

Alcotana mango fibra de vidrio. 290x41,5mm

Código	Peso	Referencia	
24164	590g	A-MFV	6



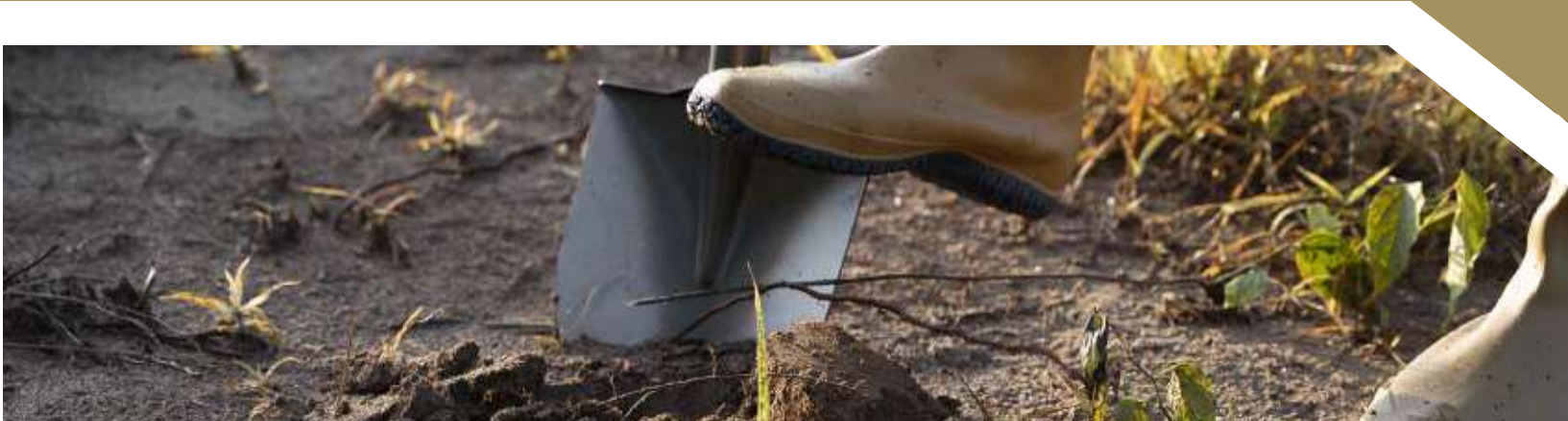

Palas y carretillas

Palas

- Fabricadas en acero templado o de aluminio, altamente resistentes, con mangos de madera y de fibra de vidrio.
- Con puntas redondas y cuadradas.

Palas

Pala punta redonda de acero templado, mango madera T

Código	Medida	Referencia	
23508	31x29cm	PPMT1	6



Acero templado
punta redonda



Mango madera
T



Pala punta redonda de acero templado, mango madera anilla

Código	Medida	Referencia	
23509	31x29cm	PPMY1	6



Acero templado
punta redonda



Mango madera
anilla



Pala punta redonda de acero templado, mango fibra vidrio T

Código	Medida	Referencia	
23510	31x29cm	PPFT1	6



Acero templado punta redonda



Mango fibra vidrio T



Pala cuadrada de acero templado, mango madera T

Código	Medida	Referencia	
23511	30x25cm	PCMT1	6



Acero templado cuadrada



Mango madera T



Pala cuadrada de acero templado, mango madera anilla

Código	Medida	Referencia	
23512	30x25cm	PCMY1	6



Acero templado cuadrada



Mango madera anilla



Pala cuadrada de acero templado, mango fibra vidrio T

Código	Medida	Referencia	
23513	30x25cm	PCFT1	6



Acero templado cuadrada



Mango fibra vidrio T



Pala cuadrada aluminio, mango madera anilla

Código	Medida	Referencia	
25765	30x25cm	PCMY2	6



Aluminio cuadrada



Mango madera anilla



Carretillas

- Estructura reforzada, varias capacidades, para uso en obra y jardín.
- Bastidor realizado con tubo de acero de Ø32x1,5mm de espesor.
- Rueda neumática impinchable.

Carretilla hormigonera 'Chino' con rueda neumática
Capacidad: 115 litros

Código	Medida	Referencia	
96282	500x900mm	1500101	1



Capacidad 115 Litros



Rueda neumática



Patas reforzadas



Carretillas

Carretilla de jardín neumática
Capacidad: 90 litros

Código	Medida	Referencia	
96281	550x950mm	1500007	1



Capacidad 115 Litros



Rueda neumática



Carretilla de obra con rueda neumática
Capacidad: 60 litros

Código	Medida	Referencia	
96279	650x830mm	1500001	1



Capacidad 60 Litros



Rueda neumática



Rueda carretilla de obra neumática

Código	Medida	Referencia	
23823	3.50/8	RP/CO	1



Neumática



Rueda carretilla de obra impinchable poliuretano

Código	Medida	Referencia	
23824	3.50/8	RP/CO-IMP	1



Impinchable poliuretano



•Todas las carretillas están hechas de tubo de acero de Ø32x1,5mm de espesor.



Mallas y señalización

Mallas de revoco

- Red de fibra de vidrio, ayuda al agarre del yeso y del mortero.
- Tamaño de cuadros, 5x5mm (yeso) y 10x10mm (mortero).

Malla de revoco para yeso 5x5mm en rollo 1x50m

Código	Medida	Referencia	
24515	5x5mmx60g/m2	MR-Y	 1x50m



Yeso



5x5mm



60g/m2



Malla de revoco para mortero 10x10mm

Código	Medida	Referencia	
24516	10x10mmx90g/m2	MR-M	 1x50m



Mortero



10x10mm



90g/m2



Mallas

Mallas de seguridad

- Para cerramiento perimetral, indicada para señalar y delimitar zonas o áreas de trabajo en obras.
- De plástico, color naranja.

Malla de seguridad construcción, naranja 100x40mm

Código	Medida	Referencia	
25241	100x40mm	MSO	1x50m



100x40mm

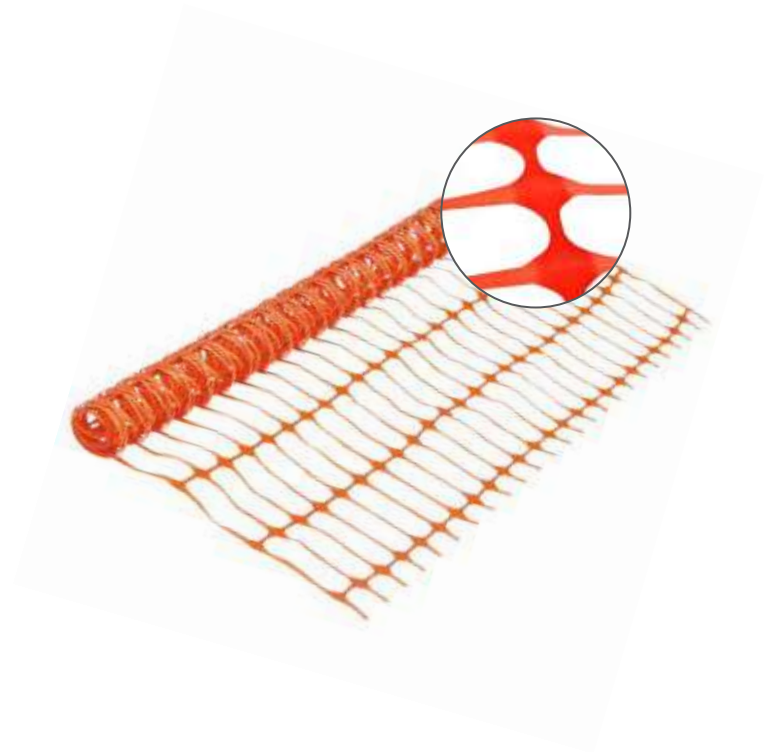

Cinta señalización

Cinta señalización

- Tira no adhesiva, de polipropileno, ideal para indicar y delimitar obstáculos y zonas peligrosas.
- De color blanco y rojo, es muy visible, resistente y flexible.

Cinta señalización roja y blanca

Código	Medida	Referencia	
--	0.75x200m	Hss340 comby	200m



No Adhesivo



EPI

Calzado de seguridad S3 SRC

- Tira no adhesiva, de polipropileno, ideal para indicar y delimitar obstáculos y zonas peligrosas.
- De color blanco y rojo, es muy visible, resistente y flexible.

CALZADO DE SEGURIDAD EN ISO 20345: 2011

S3
SRC

S3 SRC=SB+A+E+WRU+P

- SB= Zona del talón cerrada. Seguridad básica.
- A= Propiedades antiestáticas.
- E= Absorción de energía en la zona del tacón.
- WRU= Penetración y adsorción de agua.
- P= Resistente a la perforación y suela con resaltes.
- ORO= Resistencia a hidrocarburos y aceites.
- Materiales del empeine: cuero.
- Material del forro: textil.
- Material de la suela: poliuretano.
- SRC= Resistente al deslizamiento.

Requisitos adicionales



- SRC= Resistente al deslizamiento.
- SRA= Suelo: cerámico.
- +Lubricante: agua con detergente.
- SRB= Suelo: acero inoxidable
- Lubricante: glicerina.

Zapato de seguridad piel flor pigm.
collarín acolchado, punta y suela de acero

Código	Medida	Referencia	
26161	37	CS-Z	10
26162	38	CS-Z	10
26163	39	CS-Z	10
26164	40	CS-Z	10
26165	41	CS-Z	10
26166	42	CS-Z	10
26167	43	CS-Z	10
26168	44	CS-Z	10
26169	45	CS-Z	10
26170	46	CS-Z	10
26171	47	CS-Z	10

Calzado de seguridad

S3 SRC

Requisitos básicos

- Seguridad básica: zona del talón cerrada, con puntera de resistencia a golpes de 200 julios.
- A= Propiedades antiestáticas. Da 1x105 Ohm.
- E= Absorción de energía en la zona del tacón >20 julios.
- WRU=penetración >60' y adsorción de agua >30%.
- P= resistente a la perforación y suela con resaltes >1100N.
- ORO= resistencia a hidrocarburos y aceites.



**Bota de seguridad piel flor pigm.
collarín acolchado, punta y suela de acero**

Código	Medida	Referencia	
26150	37	CS-B	10
26151	38	CS-B	10
26152	39	CS-B	10
26153	40	CS-B	10
26154	41	CS-B	10
26155	42	CS-B	10
26156	43	CS-B	10
26157	44	CS-B	10
26158	45	CS-B	10
26159	46	CS-B	10
26160	47	CS-B	10



Calzado de seguridad S3 SRC

- Tira no adhesiva, de polipropileno, ideal para indicar y delimitar obstáculos y zonas peligrosas.
- De color blanco y rojo, es muy visible, resistente y flexible.

CALZADO DE SEGURIDAD EN ISO 20345: 2011

**S1P
SRC**

- SB= Zona del talón cerrada. Seguridad básica.
- A= Propiedades antiestáticas.
- E= Absorción de energía en la zona del tacón.
- P= Resistente a la perforación y suela con resaltes.
- ORO= Resistencia a hidrocarburos y aceites.
- SRC= Resistente al deslizamiento.
- Puntera metálica resistente a impactos de (>200 J).







Requisitos adicionales

- SRC= Resistente al deslizamiento.
- SRA= Suelo: cerámico.
- +Lubricante: agua con detergente.
- SRB= Suelo: acero inoxidable
- Lubricante: glicerina.

**S1P SRC
S1P SRC=
SB+A+E+P+ORO**

Requisitos básicos

- Seguridad básica: zona del talón cerrada, con puntera de resistencia a golpes de 200 julios. 
- A= Propiedades antiestáticas. Da 1x105 Ohm. a 1x108 Ohm. 
- E= Absorción de energía en la zona del tacón >20 julios. 
- P= resistente a la perforación y suela con resaltes >1100N. 
- ORO= resistencia a hidrocarburos y aceites. 

**Zapato de seguridad piel serraje pigm.
collarín acolchado, punta y suela de acero**

Código	Medida	Referencia	
25062	37	CS1P-ZS	10
25063	38	CS1P-ZS	10
25064	39	CS1P-ZS	10
25065	40	CS1P-ZS	10
25066	41	CS1P-ZS	10
25067	42	CS1P-ZS	10
25068	43	CS1P-ZS	10
25069	44	CS1P-ZS	10
25070	45	CS1P-ZS	10
25071	46	CS1P-ZS	10
25074	47	CS1P-ZS	10



Bota de seguridad piel serraje pigm.
collarín acolchado, punta y suela de acero

Código	Medida	Referencia	
20217	37	CS-BS	10
20218	38	CS-BS	10
20219	39	CS-BS	10
20220	40	CS-BS	10
20221	41	CS-BS	10
20222	42	CS-BS	10
20223	43	CS-BS	10
20224	44	CS-BS	10
20225	45	CS-BS	10
20226	46	CS-BS	10
20227	47	CS-BS	10



MEDICIÓN Y MARCAJE

Toda la precisión está en estas páginas: flexómetros, calibre y escuadras, niveles y plomadas... Ferrotech incluye en su catálogo todo lo que necesita el profesional de la construcción para responder a cualquier tipo de exigencias



Herramientas de medición	97
Flexómetros	97
Calibre y escuadras	98
Nivelación y marcaje	99
Plomadas y niveles	99
Marcaje	101



Herramientas de medición

Flexómetros

- Con triple freno para medir longitudes en superficies rectas o curvas.
- Alta resistencia. Disponible en 2, 3, 5 y 8 metros.

Flexómetros

Flexómetro triple freno

Código	Medida	Referencia	
20472	3mx19mm	FLG3-19-B	12
20473	5mx19mm	FLG5-19-B	12
20474	5mx25mm	FLG5-25-B	12



Alta resistencia
Antishock



Doble gancho



Fácil bloqueo



x2

Medición
dos caras



Flexómetro triple freno

Código	Medida	Referencia	
23233	2mx16mm	FL2-16	12
23234	3mx16mm	FL3-16	12
23235	5mx19mm	FL5-19	12
23236	5mx25mm	FL5-25	12
23237	8mx25mm	FL8-25	12



Bimaterial



Alta resistencia



Calibre y escuadras

Calibre

- Acero con alto contenido en carbono.
- Medidas: 155 milímetros. Escala métrica y pulgadas. Incluye estuche de plástico.



Calibre de acero carbono

Código	Medida	Referencia	
23428	155mm	CAL01	10

3 TIPOS DE MEDICIONES



Ø interior



Ø exterior



Profundidad



Escuadra carpintero

- Establecer ángulos rectos (ángulos de 90°) o ingleses.
- Hoja de acero inoxidable endurecido y base de aluminio.
- Escala métrica y en pulgadas a doble cara.

Escuadra carpintero inox

Código	Medida	Referencia	
26952	300mm	ESI-300	6



Doble graduación



Hoja acero inox



Mango aluminio



Falsa escuadra

- Para copiar, trazar o verificar ángulos de diferentes grados.
- Hoja de acero inoxidable endurecido y mango de aluminio.
- Graduación a doble cara. Medidas: 300 milímetros.

Falsa escuadra

Código	Medida	Referencia	
26944	300mm	FE300-INOX	10



Doble graduación



Hoja acero inox



Mango aluminio



Nivelación y marcaje

Plomadas

- Plomadas magnéticas, disponibles con pesa de forma cilíndrica (referencia vertical) y angular (referencia horizontal). Indica que la posición de un elemento constructivo está realmente a plomo.

Plomada de acero con nuez magnética

Referencia	Peso	
17208I	800g	10



Nuez magnética



Vertical



Plomadas y niveles

Plomada angular magnética

Referencia	Medida	Peso	
17999	40x40mm	100g	10



Ángulo magnético



Horizontal



Niveles

- Diseñados para indicar si un plano o una superficie se encuentran en posición perfectamente horizontal (a nivel) o vertical (aplomado).
- De aluminio, triple medición, y para forjado.



Nivel de aluminio triple medición

Código	Medida	Referencia	
25533	400mm	NL-EC400	10
25534	500mm	NL-EC500	10
25535	600mm	NL-EC600	10
25536	800mm	NL-EC800	10
25537	1000mm	NL-EC1000	10



Nivel de aluminio triple medición y mango ergonómico

Código	Medida	Referencia	
23419	400mm	NL-A400	10
23420	500mm	NL-A500	10
25305	600mm	NL-A600	10
25306	800mm	NL-A800	10
25307	1000mm	NL-A1000	10
25308	1200mm	NL-A1200	6

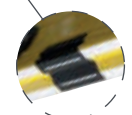

Nivel de aluminio triple medición magnético y con mango ergonómico

Código	Medida	Referencia	
23440	400mm	NL-MA400	10
23441	500mm	NL-MA500	10
23442	600mm	NL-MA600	10
23443	800mm	NL-MA800	10
23444	1000mm	NL-MA1000	10
23445	1200mm	NL-MA1200	10



Nivel forjado profesional naranja

Código	Medida	Referencia	
26597	400mm	NL-F400	10
24351	500mm	NL-F500	10
24352	600mm	NL-F600	10
24353	800mm	NL-F800	10

Manguera PVC transparente HQ

Código	Medida	Ø	Referencia	
24166	50m	8-10	MC2-50	1
24168	50m	10-12	MC4-50	1
24169	50m	10-14	MC5-50	1
24170	50m	12-15	MC6-50	1
24171	50m	15-20	MC7-50	1
26038	15m	10-12	MC4-15	1
26039	15m	10-14	MC5-15	1
26040	15m	12-15	MC6-15	1



Manguera PVC transparente

- Manguera cristal de PVC transparente para diversos usos como nivel en construcción.
- Alta flexibilidad y buen comportamiento a bajas temperaturas.

Plomadas trazadoras

- Para trazar líneas horizontales y verticales. De 15 y 30 metros.
- Fabricadas con la carcasa en zamak o ABS, que le otorgan gran resistencia.



Plomada trazadora zamak

Código	Medida	Referencia	
23425	15m	PTZ15	10
23426	30m	PTZ30	10

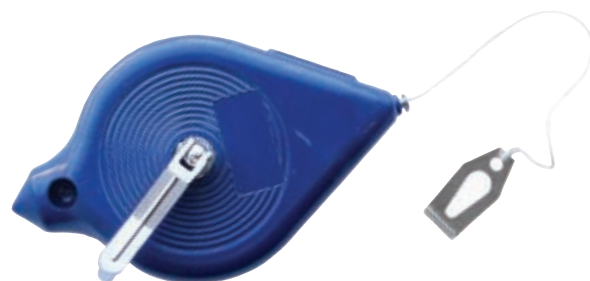

Marcaje

Plomada trazadora ABS

Código	Medida	Referencia	
23427	15m	PTA15	10



Polvo trazador azul y rojo

Código	Medida	Color	Referencia	
20357	100g	Azul	NEX0210044	6
20358	200g	Azul	NEX0510045	6
20359	1kg	Azul	NEX1110046	1



Polvo trazador

- Su función principal es la de marcar con máxima visibilidad en paredes, suelos o techos, tanto en trabajos de interiores como de exteriores.
- Disponible en color azul y en rojo.

Marcador fluorescente 400ml

Código	Artículo	Referencia		
41139	Rojo	MF-R	6	
41140	Verde	MF-V	6	
41141	Amarillo	MF-A	6	
41142	Fucsia	MF-F	6	
41143	Naranja	MF-N	6	
41147	Azul	MF-AZ	6	



Marcador fluorescente

- Alta visibilidad y precisión para el marcaje temporal en trabajos de señalización y trazado sobre todo tipo de superficies.
- Secado al tacto en 15 minutos. Disponible en varios colores.

COMPRESORES Y HERRAMIENTA NEUMÁTICA

Descubra nuestra gama de compresores y herramientas neumáticas. Compresores portátiles silenciosos, de aire de correa o monoblock, pistolas de pintura y sopladoras, manómetros, clavadoras y otras herramientas y accesorios podrá encontrarlos en nuestro catálogo.



Compresores	104	Accesorios y herramienta neumática	109
Compresores silenciosos	104	Pistolas de pintura	109
Compresores de correa	105	Pistolas sopladoras	110
Compresores monoblock	107	Manómetros	110
		Espiral y kit para compresor	111
		Clavadoras neumáticas	113



Compresores

Compresor silencioso. PRO6SILENC

- Portátil silencioso, compacto, ideal para trabajos en interior y en exterior como soplar, hinchar y óptimo para la utilización de clavadora y grapadora neumática. Ultrasilencioso. Sin mantenimiento, puede ser transportado en cualquier posición, incluso tumbado. Doble salida de aire.

Código	Referencia	VOLT.	HP.	LTS.	BAR	LT.MIN	RPM	KG.
97488	CA-PRO6SILENC	230	1	6	6	110	1400	18

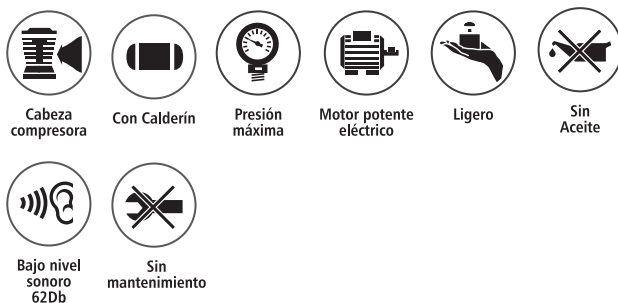

Compresor silencioso. PRO25SILENC

- Portátil silencioso, ideal para trabajos en interior y en exterior como soplar, hinchar y óptimo para la utilización de clavadora y grapadora neumática sin mantenimiento. Puede ser transportado en cualquier posición, incluso tumbado. Doble salida de aire.

Código	Referencia	VOLT.	HP.	LTS.	BAR	LT.MIN	RPM	KG.
97489	CA-PRO25SILENC	230	1,5	24	8	150	1400	20

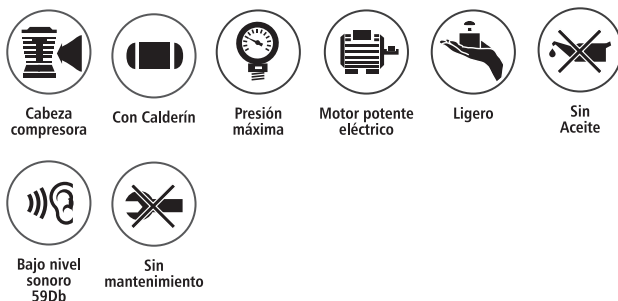









Compresores silenciosos



Compresor silencioso. PRO50SILENC

- Portátil silencioso, compacto, ideal para trabajos en interior y en exterior como soplar, hinchar y óptimo para la utilización de clavadora y grapadora neumática. Ultrasilencioso. Sin mantenimiento, puede ser transportado en cualquier posición, incluso tumbado. Doble salida de aire.

Código	Referencia	VOLT.	HP.	LTS.	BAR	LT.MIN	RPM	KG.
97490	CA-PRO50SILENC	230	1,5	50	8	150	1400	26









 Cabeza compresora	 Con Calderín	 Presión máxima	 Motor potente eléctrico	 Ligero	 Sin Aceite
 Bajo nivel sonoro 59Db	 Sin mantenimiento				



Compresor correa. CA-PRO50-3MF

- Compresor de aire de correas con cabezal de alto rendimiento, cilindros de hierro fundido para una larga vida útil, protectores de correa de acero resistentes para una protección óptima de las piezas móviles, ruedas duraderas y asas para facilitar el transporte. Diseño compacto y robusto, motor de inducción, bajo nivel de ruido.

Código	Referencia	VOLT.	HP.	LTS.	BAR	LT.MIN	RPM	KG.
97484	CA-PRO50-3MF	230	3	50	10	321	1420	51,5

 Cabeza compresora	 Con Calderín	 Presión máxima	 Motor potente eléctrico	 Transmisión por correas	 Lubricado con aceite
 Nivel sonoro 85Db	 Válido para neumática	 Pistón			











Compresores de correa

Compresor silencioso. CA-PRO100-3MF

- Compresor de aire de correas con cabezal de alto rendimiento, cilindros de hierro fundido para una larga vida útil, protectores de correa de acero resistentes para una protección óptima de las piezas móviles, ruedas duraderas y asas para facilitar el transporte. Diseño compacto y robusto, motor de inducción, bajo nivel de ruido.

Código	Referencia	VOLT.	HP.	LTS.	BAR	LT.MIN	RPM	KG.
97485	CA-PRO100-3MF	380	3	100	10	365	1375	77









					
Cabeza compresora	Con Calderín	Presión máxima	Motor potente eléctrico	Transmisión por correas	Lubricado con aceite
					
Nivel sonoro 94Db	Válido para neumática	Pistón			



Compresor silencioso. CA-PRO150-3MF

- Compresor de aire de correas con cabezal de alto rendimiento, cilindros de hierro fundido para una larga vida útil, protectores de correa de acero resistentes para una protección óptima de las piezas móviles, ruedas duraderas y asas para facilitar el transporte. Diseño compacto y robusto, motor de inducción, bajo nivel de ruido.

Código	Referencia	VOLT.	HP.	LTS.	BAR	LT.MIN	RPM	KG.
97486	CA-PRO150-3MF	380	3	150	10	365	1375	86,5









					
Cabeza compresora	Con Calderín	Presión máxima	Motor potente eléctrico	Transmisión por correas	Lubricado con aceite
					
Nivel sonoro 85Db	Válido para neumática	Pistón			



Compresor silencioso. CA-AB200/3M

• Profesional, cabezal de aleación de aluminio con dos cilindros de hierro fundido. Potente motor eléctrico con protección térmica. Transmisión por correas. Equipado con presostato para el arranque y parada del motor. Regulador de presión con dos salidas. Opción de monofásico o trifásico.

Código	Referencia	VOLT.	HP.	LTS.	BAR	LT.MIN	RPM	KG.
97487	CA-AB200/3M	380	3	200	10	348	1500	88

 Cabeza compresora	 Con Calderín	 Presión máxima	 Motor potente eléctrico	 Transmisión por correas	 Lubricado con aceite
 Nivel sonoro 85Db	 Válido para neumática	 Pistón			



Compresor monoblock. CA-PRO7

• Compresor portátil. Ideal para trabajos de desplazamiento. Protección térmica del motor. Sin mantenimiento.

Código	Referencia	VOLT.	HP.	LTS.	BAR	LT.MIN	RPM	KG.
97481	CA-PRO7N	230	1,5	6	8	160	2850	11

 Transporte manual	 Cabeza compresora	 Con Calderín	 Ligero	 Sin Mantenimiento	 Sin Aceite
 Nivel sonoro 97Db	 Motor eléctrico				



Compresores monoblock

Compresor monoblock. CA-PRO25

- Compresor monoblock con transmisión directa. Equipado con asa y ruedas que facilitan su transporte. Cubremotor ergonómico. Lubricado con aceite para una mayor duración. Doble salida de aire regulada y directa.

Código	Referencia	VOLT.	HP.	LTS.	BAR	LT.MIN	RPM	KG.
97482	CA-PRO25	230	2	25	8	195	2850	22



Lubricado con aceite



Con calderín



Ligero



Cabeza compresora



Nivel sonoro 92Db



Compresor monoblock. CA-PRO55

- Compresor monoblock con transmisión directa. Equipado con asa y ruedas que facilitan su transporte. Cubremotor ergonómico. Lubricado con aceite para una mayor duración. Doble salida de aire regulada y directa.

Código	Referencia	VOLT.	HP.	LTS.	BAR	LT.MIN	RPM	KG.
97483	CA-PRO55	230	2	50	8	195	2850	30



Lubricado con aceite



Con Calderín



Ligero



Cabeza compresora



Nivel sonoro 90Db





Accesorios y herramienta neumática

Pistolas de pintura

Pistolas de pintura neumática

- Pistola profesional aerográfica por gravedad. Depósito de plástico 600ml.
- Cuenta con mango ergonómico para una máxima precisión y comodidad.
- Regulador para la amplitud del flujo.

Pistola de pintura neumática

Código	Presión	Salida	Referencia	
26025	3-4 bar	1,4mm	PP1.4A	6
26026	3-4 bar	1,7mm	PP1.7A	6
26027	3-4 bar	2,0mm	PP2.0A	6

- Presión de trabajo: 3.0-4.0bares/43-58 PSI.
- Consumo de aire: 6.0-11 PCM.
- Rosca de entrada del aire: 1/4 BSP.
- Recipiente (taza): 600ml.
- Material del cuerpo: aluminio.
- Material de la taza: prolipropileno.
- Material de la boquilla y aguja: acero inoxidable.

Depósito para pistola de pintura

Código	Presión	Capacidad	Referencia	
26375	3-4 bar	500ml	DPP	6



Pistolas sopladoras

Pistola sopladora de aire

Código	Presión trab.	Referencia	
26030	0-10 bar	PSA	10

- Presión de trabajo: 0-10 bar.
- Máxima presión: 15 bar.
- Rosca de entrada del aire: 1/4 BSP.

Pistola sopladora

Código	Presión	Medida	Referencia	
27131	12 bar	1/4"	PSNY	25

- Presión de trabajo: 0-10 bar.
- Máxima presión: 12 bar.
- Rosca de entrada del aire: 1/4 BSP.



Pistolas sopladoras

- Ideal para limpiar virutas y restos de polvo durante la fabricación o el montaje.
- Conector rápido. Boquilla de acceso para huecos difíciles.

Manómetros y espirales

Manómetro, cuerpo acero

Código	Presión trab.	Medida	Referencia	
26031	0-150 PSI	1/4"	MAN01	10

- Presión de trabajo: 0-10 bar.
- Máxima presión: 12 bar.
- Rosca de entrada del aire: 1/4".



Manómetro de presión

- Sirve para medir la presión y aumentarla o disminuirla según la necesidad.
- El rango de medición está entre 0 y 12 bar.

Manómetro, mango aluminio

Código	Presión	Medida	Referencia	
27130	12 bar	1/4"	MAN02	10

- Presión de trabajo: 0-15 bar.
- Máxima presión: 12 bar.
- Rosca de entrada del aire: 1/4".



Espiral para compresor

- Manguera espiral de poliuretano especial para su uso en instalaciones de aire comprimido, compresores y herramientas neumáticas.



Espiral con 2 conectores macho de 1/4"

Código	Øint x Øext	Medida	Referencia	
26032	6,5x10	7,5m	ESP7.5	1
26033	6,5x10	10m	ESP10	1
26034	6,5x10	15m	ESP15	1

- Conectores: 2.
- Máxima presión: 15 bar.
- Medida conector: 1/4".

Kit 5 piezas para compresor

- Pistolas de pintura y de aire comprimido, inflador de neumáticos con manómetro, manguera de aire y accesorios de aire comprimido.

**5
PZAS**



Kit 5 piezas, pistolas de pintura y manómetro

Código	Referencia	
26028	KIT5PP/M	1

- 1 Pistola de pulverización para pintura con vaso de gravedad.
- 2 Pistola de aire comprimido que se puede utilizar como dispositivo de soplado y pistola con ventosa.
- 3 Inflador de neumáticos con manómetro.
- 4 Manguera de aire en espiral de 4 m.
- 5 Conjunto de accesorios de aire comprimido con 5 unidades para las aplicaciones más comunes de aire comprimido.



Clavadora neumática

- Muy prácticas y útiles en aplicaciones para bricolaje y profesional.
- El mango está envuelto con goma antideslizante.

Clavadora neumática p/150 clavos brad 0,6mm (12~35mm)

Código	Acabado	Medida	Referencia	
41160	Azul	220x205x50mm	CLAV P-150	10



Empuñadura y punta de goma



Seguro de doble gatillo



Adaptador giratorio

Clavadora para brad 0.6 hasta 35mm. Clavadora de línea bricolaje. Buena relación calidad/precio. Morro reducido y sin obstáculos para clavar sobre superficies de trabajo curvas. Dispone de protector de goma para no dañar las superficies de trabajo. Carro de aluminio con empujadores múltiples. Ventana indicadora de carro vacío. Difusor de aire giratorio (360°). Seguro de doble gatillo.

- **Peso:** 990g.
- **Medidas:** 220x205x50mm.
- **Compresor recomendado:** 1cv / 3ltrs.
- **Clavo utilizado:** brad 0.64 (12~35mm).
- **Capacidad cargador:** 150 brad.

Clavadora neumática p/120 clavos brad/pin 0,6mm (12~35mm)

Código	Acabado	Medida	Referencia	
41161	Gris	220x177x40mm	CLAV P-140	10



Empuñadura y punta de goma



Seguro de doble gatillo



Adaptador giratorio

Clavadora para brad y pin de 0,6mm. Se trata de una máquina con grandes prestaciones y calidad profesional, siendo a la vez muy manejable y cómoda de usar. Posee empuñadura de goma para reducir la fatiga en usos prolongados. El morro es reducido para acceder a lugares difíciles. Carro aluminio para brad y pin. Ventana indicadora de carro vacío. Sistema de seguridad de doble gatillo.

- **Peso:** 900g.
- **Medidas:** 220x177x40mm.
- **Compresor recomendado:** 1cv / 3ltrs.
- **Clavo utilizado:** pin 0.64 (10~30mm) Brad 0.64 (12~30mm).
- **Capacidad cargador:** 120 pin/brad.



Clavadoras neumáticas



PARA
150
BRAD



PARA
120
BRAD/PIN

Lengüeta completa, pistón, lengüeta y junta, para clavadora neumática CLAV P-150

Código	Referencia	
41162	L-CLAV-P-150	1

Lengüeta completa, pistón, lengüeta y junta, para clavadora neumática CLAV P-140

Código	Referencia	
41163	L-CLAV-P-140	1

PINTURA Y ACCESORIOS

La firma Ferrotech tiene todo lo que necesitas en pintura y accesorios. Esmaltes de acabado y preparación, pinturas en spray, accesorios para pintura... Una paleta de posibilidades para tus proyectos. ¡Y dale color a tus espacios!



Esmaltes de acabado y preparación 115

Esmaltes y barnices de acabado	115
Pinturas de preparación	117
Pinturas especiales	118
Decapantes y diluyentes	118

Pinturas en spray 120

Pintura y barniz acrílico	120
Pinturas spray especiales	122

Accesorios para pintura

123	
Brochas y pinceles	123
Rodillos y recambios	124
Accesorios pintura	126



Esmaltes de acabado y preparación

Esmalte sintético

- Es una de las mejores opciones para pintar maderas y metales en interiores y exteriores gracias a su resistencia, sus diversos acabados y colores disponibles.
- Gran dureza, elasticidad, resistencia a la intemperie y al amarillo.

Esmalte sintético. Disolución y limpieza con disolvente

Código	Artículo	Medida	Referencia	
27664	Negro mate	250ml	ESM-SINT	
27362	Negro mate	750ml	ES-0002	
27363	Negro mate	4l	ES-0003	
27665	Negro sat.	250ml	ESM-SINT	
27364	Negro sat.	750ml	ES-0008	
27365	Negro sat.	4l	ES-0009	
27666	Negro brillo	250ml	ESM-SINT	
27366	Negro brillo	750ml	ES-0014	
27367	Negro brillo	4l	ES-0015	
27667	Blanco mate	250ml	ESM-SINT	
27368	Blanco mate	750ml	ES-0020	
27369	Blanco mate	4l	ES-0021	
27668	Blanco sat.	250ml	ESM-SINT	
27370	Blanco sat.	750ml	ES-0026	
27371	Blanco sat.	4l	ES-0027	
27669	Blanco brillo	250ml	ESM-SINT	
27372	Blanco brillo	750ml	ES-0032	
27373	Blanco brillo	4l	ES-0033	
27671	Gris plata brillo	250ml	ESM-SINT	
27374	Gris plata brillo	750ml	ES-0041	
27375	Gris plata brillo	4l	ES-0042	
27672	Gris perla brillo	250ml	ESM-SINT	
27376	Gris perla brillo	750ml	ES-0044	
27377	Gris perla brillo	4l	ES-0045	
27673	Gris azulado brillo	250ml	ESM-SINT	
27378	Gris azulado brillo	750ml	ES-0050	
27379	Gris azulado brillo	4l	ES-0051	
27674	Gris medio brillo	250ml	ESM-SINT	
27380	Gris medio brillo	750ml	ES-0056	
27381	Gris medio brillo	4l	ES-0057	
27680	Verde prim. brillo	250ml	ESM-SINT	
27382	Verde prim. brillo	750ml	ES-0065	
27383	Verde prim. brillo	4l	ES-0066	
27682	Verde mayo brillo	250ml	ESM-SINT	
27386	Verde mayo brillo	750ml	ES-0071	
27387	Verde mayo brillo	4l	ES-0072	
27683	Verde carruaje brillo	250ml	ESM-SINT	
27388	Verde carruaje brillo	750ml	ES-0074	
27389	Verde carruaje brillo	4l	ES-0075	
27681	Verde hierba	250ml	ESM-SINT	
27384	Verde hierba	750ml	ES-0068	
27385	Verde hierba	4l	ES-0069	
27705	Azul luminoso	250ml	ESM-SINT	
27446	Azul luminoso	750ml	ES-0125	
27447	Azul luminoso	4l	ES-0126	
27707	Azul cobalto	250ml	ESM-SINT	
27448	Azul cobalto	750ml	ES-0128	
27449	Azul cobalto	4l	ES-0129	

Esmaltes y barnices de acabado



Código	Artículo	Medida	Referencia	
27687	Marrón tabaco brillo	250ml	ESM-SINT	
27390	Marrón tabaco brillo	750ml	ES-0080	
27391	Marrón tabaco brillo	4l	ES-0081	
27686	Pardo brillo	250ml	ESM-SINT	
27392	Pardo brillo	750ml	ES-0086	
27393	Pardo brillo	4l	ES-0087	
27692	Ocre brillo	250ml	ESM-SINT	
27394	Ocre brillo	750ml	ES-0092	
27395	Ocre brillo	4l	ES-0093	
27694	Amarillo real brillo	250ml	ESM-SINT	
27396	Amarillo real brillo	750ml	ES-0098	
27397	Amarillo real brillo	4l	ES-0099	
27695	Amarillo medio brillo	250ml	ESM-SINT	
27398	Amarillo medio brillo	750ml	ES-0101	
27399	Amarillo medio brillo	4l	ES-0102	
27696	Naranja brillo	250ml	ESM-SINT	
27400	Naranja brillo	750ml	ES-0104	
27401	Naranja brillo	4l	ES-0105	
27698	Rojo bermellón brillo	250ml	ESM-SINT	
27402	Rojo bermellón brillo	750ml	ES-0110	
27403	Rojo bermellón brillo	4l	ES-0111	
27699	Rojo vivo brillo	250ml	ESM-SINT	
27404	Rojo vivo brillo	750ml	ES-0113	
27405	Rojo vivo brillo	4l	ES-0114	
27700	Rojo carruaje vivo	250ml	ESM-SINT	
27406	Rojo carruaje vivo	750ml	ES-0116	
27407	Rojo carruaje vivo	4l	ES-0117	
27702	Rojo inglés brillo	250ml	ESM-SINT	
27408	Rojo inglés brillo	750ml	ES-0122	
27409	Rojo inglés brillo	4l	ES-0123	



Rodillo



Pistola



Brocha



Interior





Exterior



Esmalte sintético oro

- Ideal para manualidades y decoración: dorado de molduras, marcos, adornos...
- Ofrece gran finura en los acabados.

Código	Artículo	Medida	Referencia
27708	Oro amarillo	250ml	PURP-ORO 
27709	Oro viejo	250ml	PURP-ORO 

Esmalte antioxidante

- Protege los metales ferrosos, como el hierro, la forja o el acero, evitando su oxidación.
- Acabado efecto forja (granulado).
- Aplicación interior y exterior.



OXI-NIO5 EFECTO FORJA

Código	Artículo	Medida	Referencia
27711	Negro forja	250ml	ESM-OXI 
27422	Negro forja	750ml	EO-0221
27423	Negro forja	4l	EO-0222
27712	Gris forja	250ml	ESM-OXI 
27424	Gris forja	750ml	EO-0224
27425	Gris forja	4l	EO-0225

Esmalte sintético antioxidante

Código	Artículo	Medida	Referencia
27713	Blanco brillo	250ml	ESM-ANTI 
27451	Blanco brillo	750ml	EAX-1232244
27452	Blanco brillo	4l	EAX-1232242
27714	Negro brillo	250ml	ESM-ANTI 
27453	Negro brillo	750ml	EAX-1232239
27454	Negro brillo	4l	EAX-1232240
27717	Verde carruaje brillo	250ml	ESM-ANTI 
27457	Verde carruaje brillo	750ml	EAX-1232250
27463	Verde carruaje brillo	4l	EAX-1231850A
27716	Gris brillo	250ml	ESM-ANTI 
27456	Gris brillo	750ml	EAX-1232246
27715	Tabaco brillo	250ml	ESM-ANTI 
27455	Tabaco brillo	750ml	EAX-1232248
27718	Pardo brillo	250ml	ESM-ANTI 
27458	Pardo brillo	750ml	EAX-1232254

Código	Artículo	Medida	Referencia
27459	Rojo brillo	4l	EAX-1230745 
27460	Azul luminoso	4l	EAX-1231640 
27461	Negro mate	4l	EAX-1232225A 
27462	Negro satinado	4l	EAX-1232215A 
27464	Blanco mate	4l	EAX-1232125A 
27465	Blanco satinado	4l	EAX-1232115A 

Barniz sintético incoloro

Código	Artículo	Medida	Referencia
27660	Int.-ext. sat. incoloro	250ml	BRNZ-SINT
27580	Int.-ext. sat. incoloro	750ml	BRNZ-SINT
27581	Int.-ext. sat. incoloro	4l	BRNZ-SINT
27661	Int.-ext. br. incoloro	250ml	BRNZ-SINT
27582	Int.-ext. br. incoloro	750ml	BRNZ-SINT
27583	Int.-ext. br. incoloro	4l	BRNZ-SINT

Barniz marino sintético incoloro. Especial barcos

Código	Artículo	Medida	Referencia
27662	Marino int.-ext. br. inc.	250ml	BRZM-SINT
27584	Marino int.-ext. br. inc.	750ml	BRZM-SINT
27585	Marino int.-ext. br. inc.	4l	BRZM-SINT



Barniz sintético

- Protege la madera creando una capa impermeable de gran adherencia, que resalta su veteado natural.
- Caracterizado por su dureza, elasticidad y brochabilidad.
- Disponible también para barcos, con empleo en maderas de exterior sometidas a condiciones climáticas extremas.



Aceite de linaza

Código	Artículo	Medida	Referencia	
27588	Crudo	1l	AC/LNZ	1
27589	Secante	1l	AC/LNZ	1









Aceite de linaza

- Nutre, abrillanta, repara o barniza superficies y muebles de madera.
- Protección natural, buena resistencia a las inclemencias del tiempo.



Imprimación sintética

- Protección y preparación de superficies de hierro y acero, tanto en interiores como en exteriores.
- Buena brochabilidad y gran facilidad de aplicación.

Código	Artículo	Medida	Referencia	
27410	Metal rojo inglés	750ml	IS-0200	
27415	Metal rojo inglés	4l	IS-0202	
27416	Metal rojo inglés	15l	IS-0203	
27413	Metal negro	15l	IS-0214	
27414	Metal blanca	15l	IS-0215	
27417	Metal gris	750ml	IS-0204	
27418	Metal gris	4l	IS-0205	
27419	Metal gris	15l	IS-0206	
27420	Fosfatante galv. gris	750ml	IS-0208	
27421	Fosfatante galv. gris	4l	IS-0209	



Pinturas de preparación



Fondo sintético tapaporos

- Sella los poros de la madera y regula la absorción de la superficie.
- No altera el color de la madera.

Fondo sintético tapaporos

Código	Artículo	Medida	Referencia	
27663	Incoloro	250ml	FOND/TAP	
27586	Incoloro	750ml	FOND/TAP	
27587	Incoloro	5l	FOND/TAP	



Pinturas especiales

Pintura especial piscinas

Código	Artículo	Medida	Referencia
27536	Pintura cloro caucho	4l	PINT-PISC/4L



Pintura cloro caucho

- Pintura adecuada para piscinas, resistente al agua, al cloro y a otros productos que se usan para tratar el agua.
- Cuenta con propiedades impermeabilizantes.



Decapantes y diluyentes

Decapante

Código	Artículo	Medida	Referencia	
27726	Quitapinturas	250ml	DECA	1
27426	Quitapinturas	750ml	DECA0301	1



Decapante

- Para eliminar capas de pintura, esmaltes, barnices, lasures... en diferentes materiales.
- Se usa en varios tipos de soportes: madera, metal, cemento, azulejos o vidrio. Inadecuado para plásticos.



Disolvente universal

Código	Medida	Referencia	
27474	500ml	DIS-UNIV	30
27480	1l	DIS-UNIV	16
27481	5l	DIS-UNIV	4
27482	25l	DIS-UNIV	1

**Disolvente universal**

- Ideal para la limpieza de los útiles utilizados en los diferentes sistemas de pintado o barnizado de superficies (brochas, pistolas e instalaciones de pintado en general).
- Limpieza y preparación de superficies para su pintado. Puede utilizarse como desengrasante.

Disolvente nitro

Código	Medida	Referencia	
27483	1l	NITRO-UNI	16
27484	5l	NITRO-UNI	4

**Disolvente nitro**

- Garantiza un resultado óptimo en la disolución de toda clase de pinturas, lacas, barnices y todos los derivados nitrocelulósicos.
- Se utiliza tanto para la limpieza de utensilios de pintores, para disolver las pinturas y tintas, como para limpiar brochas, pistolas, rodillos, pinceles, etc.

Disolvente clorocaucho

Código	Medida	Referencia	
27537	1l	DIS-CLOR	16

**Disolvente clorocaucho**

- Especial diluyente para las pinturas de clorocaucho, así como para la limpieza de utensilios.
- También es adecuado su uso como desengrasante.

Aguarrás profesional

Código	Medida	Referencia	
27485	500ml	AGU-PRO	25
27486	1l	AGU-PRO	16

**Aguarrás profesional**

- Líquido incoloro, se utiliza como diluyente de pinturas o barnices sintéticos, limpieza de utensilios y manchas de pintura.
- Confiere buena brochabilidad y facilita el uso.

Símil aguarrás

Código	Medida	Referencia	
27487	500ml	SIM-AGU	25
27488	1l	SIM-AGU	16

Símil aguarrás

- Se utiliza como disolvente de alta calidad para la disolución de esmaltes, barnices e imprimaciones sintéticos, grasos y óleos.
- También se emplea para limpieza de útiles de pintura.

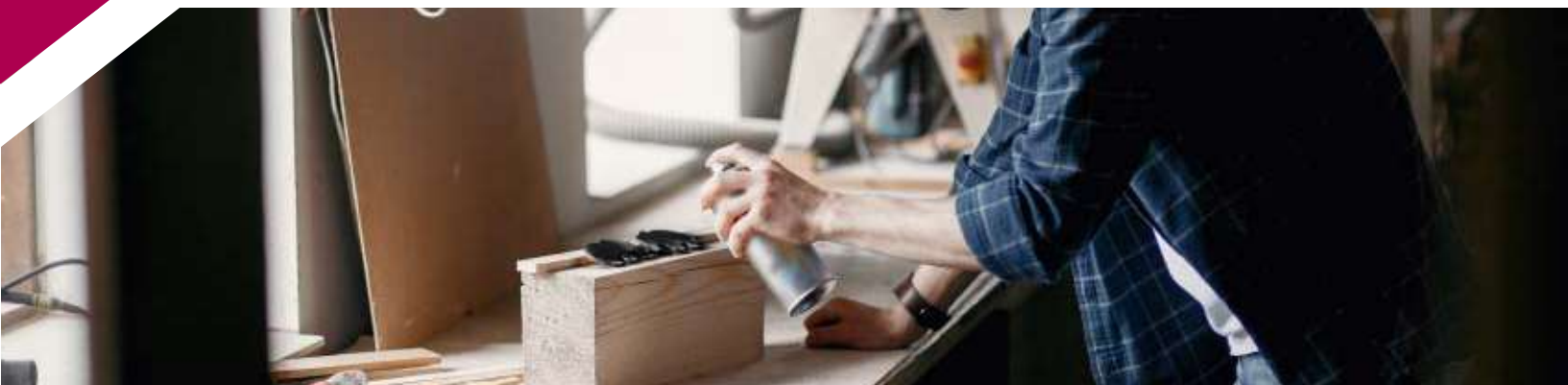

Pinturas en spray

Pintura y barniz acrílico

Pinturas RAL











- Están indicadas para pintar sobre todo tipo de superficies: madera, metal, cristal, cerámica o cemento.
- Seca al tacto a los 15 minutos de aplicarla.













Pintura acrílica en spray 400ml



Código	Artículo	Referencia		
41080	Marfil claro RAL 1015	TOT-1015	6	
41081	Amarillo azufre RAL 1016	TOT-1016	6	
41082	Amarillo zinc RAL 1018	TOT-1018	6	
41083	Amarillo tráfico RAL 1023	TOT-1023	6	
41084	Amarillo melón RAL 1028	TOT-1028	6	
41085	Naranja pastel RAL 2003	TOT-2003	6	
41086	Naranja puro RAL 2004	TOT-2004	6	
41087	Rojo fuego RAL 3000	TOT-3000	6	
41088	Rojo rubí RAL 3003	TOT-3003	6	
41089	Rojo vino RAL 3005	TOT-3005	6	
41090	Rojo tráfico RAL 3020	TOT-3020	6	

41093	Azul zafiro RAL 5003	TOT-5003	6	
41094	Azul genciana RAL 5010	TOT-5010	6	
41095	Azul claro RAL 5012	TOT-5012	6	
41096	Azul cielo RAL 5015	TOT-5015	6	
41097	Azul tráfico RAL 5017	TOT-5017	6	
41098	Verde esmeralda RAL 6001	TOT-6001	6	
41099	Verde primavera RAL 6002	TOT-6002	6	
41100	Verde musgo RAL 6005	TOT-6005	6	
41101	Verde abeto RAL 6009	TOT-6009	6	

41091	Lila RAL 4005	TOT-4005	
41092	Púrpura RAL 4006	TOT-4006	
41104	Gris hierro RAL 7011	TOT-7011	
41105	Gris antracita RAL 7016	TOT-7016	
41106	Gris piedra RAL 7030	TOT-7030	
41107	Gris claro RAL 7035	TOT-7035	
41108	Gris ágata RAL 7038	TOT-7038	
41109	Gris aluminio RAL 9006	TOT-9006	
41110	Marrón cobre RAL 8004	TOT-8004	
41111	Marrón pardo RAL 8007	TOT-8007	
41112	Marrón nogal RAL 8011	TOT-8011	

41102	Verde hierba RAL 6018	TOT-6018	
41103	Gris plateado RAL 7001	TOT-7001	
41113	Marrón sepia RAL 8014	TOT-8014	
41114	Marrón cacao RAL 8017	TOT-8017	
41115	Negro brillo RAL 9005	TOT-9005	
41116	Negro mate RAL 9005	TOT-9005M	
41117	Negro satinado RAL 9005	TOT-9005S	
41118	Blanco crema RAL 9001	TOT-9001	
41119	Blanco brillo RAL 9010	TOT-9010	
41120	Blanco mate RAL 9010	TOT-9010M	
41121	Blanco satinado RAL 9010	TOT-9010S	
41122	Esmalte blanco electrodoméstico RAL 9010	TOT-EL	

Barniz acrílico 400ml

Código	Artículo	Referencia		
41124	Transparente mate	TOT-BAR-TM	6	
41123	Transparente brillo	TOT-BAR-TB	6	

Barniz acrílico spray

- Elemento esencial a la hora de proteger las superficies pintadas, con el fin de mejorar la durabilidad y resistencia de la pintura.
- El uso del barniz también se extiende a superficies sin pintar, como madera, plástico o metal, con el objetivo también de modificar su acabado.



Pintura spray altas temperaturas 400ml

Código	Artículo	Referencia		
41144	Negro mate	TOT-AT-N	6	
41145	Aluminio	TOT-AT-A	6	
41146	Gris antracita	TOT-AT-GA	6	



Pinturas spray especiales

Pintura altas temperaturas

- Protege la superficie de las llamas y también de sus efectos corrosivos. Es perfecta para pintar o barnizar estufas, calderas, hornos, tubos, barbacoas...
- Soporta temperaturas hasta 700°C.

Pintura spray altas temperaturas 400ml

Código	Artículo	Referencia		
25164	Zinc claro	NZINC	6	



Pintura galvanizada zinc claro

- Solidifica químicamente produciendo un revestimiento metálico de elevada duración.
- Protege todas las superficies metálicas de la oxidación.

Marcador fluorescente 500ml

Código	Artículo	Referencia		
41139	Rojo	MF-R	6	
41140	Verde	MF-V	6	
41141	Amarillo	MF-A	6	
41142	Fucsia	MF-F	6	
41143	Naranja	MF-N	6	
41147	Azul	MF-AZ	6	



Marcador fluorescente

- Alta visibilidad y precisión para el marcaje temporal en trabajos de señalización y trazado sobre todo tipo de superficies.
- Secado al tacto en 15 minutos. Disponible en varios colores.



Accesorios para pintura

Brochas y pinceles

- De cerda natural o sintética, con mango de madera.
- Su alta densidad de pelos optimiza el uso de producto y garantiza una aplicación homogénea.

Brochas y pinceles

Brocha de cerda natural. Mango de madera

Código	Medida	Nº	Referencia	
23856	20x38x7mm	9	BCN1	24
23857	25x38x8mm	12	BCN1	24
23858	30x38x9mm	15	BCN1	24
23859	40x44x9,5mm	18	BCN1	24
23860	45x44x9,5mm	21	BCN1	24
23861	50x51x10mm	24	BCN1	12
23862	55x51x11mm	27	BCN1	12
23863	60x55x11mm	30	BCN1	12



Brocha doble de cerda natural. Mango de madera

Código	Medida	Nº	Referencia	
23864	20x44x12mm	9	BCN1	24
23865	25x44x12mm	12	BCN1	24
23866	30x51x12mm	15	BCN1	24
23867	40x51x12mm	18	BCN1	24
23868	45x51x13mm	21	BCN1	24
23869	50x57x13mm	24	BCN1	12
23870	55x57x14mm	27	BCN1	12
23871	60x60x15mm	30	BCN1	12
23872	65x64x15mm	33	BCN1	12



Brocha triple de cerda natural. Mango de madera

Código	Medida	Nº	Referencia	
23873	25x44x13mm	12	BCN1	24
23874	40x51x14mm	18	BCN1	12
23875	50x57x15mm	24	BCN1	12
23876	60x60x17mm	30	BCN1	12
23877	70x64x18mm	36	BCN1	12



*Medida: ancho x largo x espesor

Pincel redondo de cerda natural para recorte con mango de madera

Código	Medida	Referencia	
21982	15x48mm	PR-15	12
21983	18x49mm	PR-18	12
21984	21x54mm	PR-21	12
21985	25x54mm	PR-25	12
21986	27x60mm	PR-27	12
21987	29x60mm	PR-29	12
21988	33x61mm	PR-33	12
21989	36x62mm	PR-36	12



*Medida: Ø x largo

Brocha de cerda natural. Mango de madera redondo

Código	Medida	Nº	Referencia	
23878	75x55x20mm	3	BCN2	12
23879	100x55x20mm	4	BCN2	12
23880	125x62x20mm	5	BCN2	12
23881	150x62x20mm	6	BCN2	6

Brocha de cerda sintética. Mango de madera redondo

Código	Medida	Nº	Referencia	
23882	75x55x20mm	3	BCN1	12
23883	100x63x20mm	4	BCN1	12
23884	125x63x20mm	5	BCN1	12
23885	150x63x20mm	6	BCN1	6

**Rodillos y recambios****Rodillos y repuestos**

- De pelo suave y corto para acabados lisos y de pelo más duro y largo para superficies rugosas, ásperas o irregulares. También para crear relieves.
- Fácil de limpiar.

Rodillo de lana merina, varilla cromada. Acabado mango amarillo

Código	Medida	Referencia	
26456	18cm	ROD-L	12
26457	22cm	ROD-L	12

**Rodillo de lana acrílica, varilla cromada. Acabado mango amarillo**

Código	Medida	Referencia	
26458	22cm	ROD-A	12
26459	18cm	ROD-A	12



Rodillo de esponja

Código	Medida	Referencia	
26460	22cm	ROD-E	12



Rodillo acrílico antigota

Código	Medida	Referencia	
20568	18cm	ROD-ANT	12
20569	22cm	ROD-ANT	12



Rodillo de recambio antigota

Código	Medida	Referencia	
26461	11x4cm	REC-A	12
26462	15x4cm	REC-A	12



Rodillo de recambio microfibras

Código	Medida	Referencia	
26463	11x5cm	REC-ROD	12



Minirrodillo de recambio espuma

Código	Medida	Referencia	
26464	5x3,5cm	ROD-MINI-E	12
26465	11x3,5cm	ROD-MINI-E	12



Minirrodillo de recambio flocado

Código	Medida	Referencia	
26466	5x3,5cm	ROD-MINI-F	12
26467	11x3,5cm	ROD-MINI-F	12



Mango para minirrodillo

Código	Medida	Referencia	
26468	50mm	M-ROD	12
26469	110mm	M-ROD	12
26470	150mm	M-ROD	12



Accesorios pintura

Minicubeta para escurrir rodillos

Código	Medida	Referencia	
26471	100mm	CUB-MINI	12



Mango telescópico Ø21-25mm

Código	Medida	Referencia	
20566	1-2m	MTL-ROD	1
20567	1,5-3m	MTL-ROD	1



Mezclador de pintura

Código	Medida	Ø	Referencia	
25280	120x600mm	10	MP001	12
26379	100x500mm	10	MP002	12
26380	80x400mm	8	MP003	12



Set 4 espátulas de carrocerero. Acero inoxidable (AI)
Acero carbono (AC)

Código	Medida	Acabado	Referencia	
26472	5-8-10-12mm	Azul	SET-EC-AI	12
26473	5-8-10-12mm	Rojo	SET-EC-AC	12



Cinta de carrocerero para enmascarar

Referencia	Medida	
A-081	18mx45mm	64
A-081	24mx45mm	48
A-081	30mx45mm	40
A-081	36mx45mm	32
A-081	48mx45mm	36
A-081	60mx45mm	20



Decoración



Construcción



Carrocería



Interiores



Blanco Natural



120 Micras



Resist. 80°C



Multisuperficie



45 Metros



No Residuos



ADHESIVOS Y SELLADORES

Los adhesivos y selladores son artículos indispensables para cualquier profesional. Lo podrás encontrar en formato barra, aplicados con pistolas o en formato líquido, muy empleado para trabajos de bricolaje o decoración.



Siliconas, selladores y masillas

129

Siliconas

129

Selladores

130

Masillas

131

Adhesivos y anclaje químico

132

Polímeros y adhesivos

132

Cintas adhesivas y films

135

Anclaje químico

138

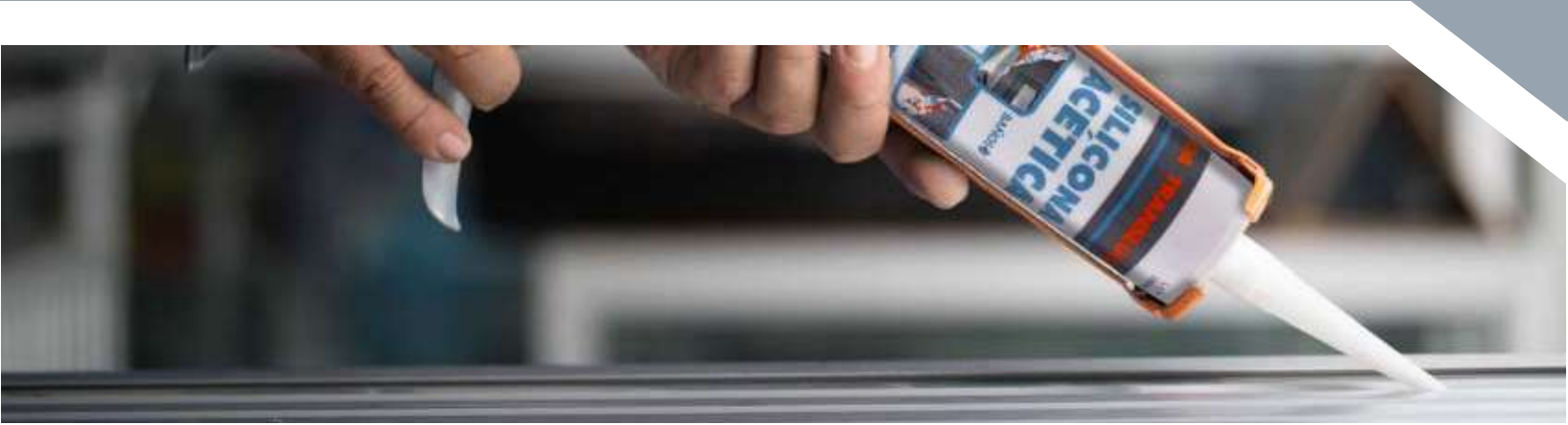

Siliconas, selladores y masillas

Silicona neutra

- De primera calidad para construcción, excepcional adherencia sobre la mayoría de materiales de construcción, porosos y no porosos.
- Especialmente indicado para el sellado de juntas de dilatación, acristalamiento y sellado de todo tipo de carpintería a obra (PVC, madera, metal, aluminio, lacado, etc.).

Silicona neutra 300ml

Código	Acabado	Referencia	
24326	Blanca	SIL-NEU	24
24327	Traslúcida	SIL-NEU	24



Juntas y uniones



Aluminio



Vidrio

Silicona acética

- Sellador de silicona acética con fungicida para acristalamiento, carpintería, sellado en baños, cocinas, etc.
- Excelente adherencia sobre vidrio, aluminio, cerámica, superficies vitrificadas y otros materiales no porosos.

Silicona acética 280ml

Código	Acabado	Referencia	
24324	Blanca	SIL-ACE	24
24325	Traslúcida	SIL-ACE	24



Baños y cocinas



Aluminio



Vidrio



Contiene fungicida

Selladores

Sellador acrílico

- Sellador plastoelástico monocomponente de alta calidad a base de dispersiones acrílicas.
- Ideal para juntas de pared exteriores e interiores, ventanas y juntas perimetrales de puertas en edificación, incluyendo la cara.

Sellador acrílico 310ml

Código	Acabado	Referencia	
26580	Blanco	SELL-ACR	24
27887	Gris	SELL-ACR	24



Pintable



Resistente rayos UV



Interior exterior



Sellado de juntas y grietas



Buena adherencia superficie porosas



Pintable y barnizable

Sellador para madera

- Sellador elástico para todo tipo de madera. Para juntas entre piezas de madera o madera a obra.
- No ennegrece, no desprende olores y se limpia con agua. Apto para uso interior y exterior. Barnizable y pintable.

Sellador madera 300ml

Código	Acabado	Referencia	
27876	Blanco	SELL-MAD300	12
27877	Pino	SELL-MAD300	12
27878	Roble	SELL-MAD300	12
27879	Haya	SELL-MAD300	12
27880	Cerezo	SELL-MAD300	12
27881	Nogal	SELL-MAD300	12
27885	Wengue	SELL-MAD300	12



Elástico



Pintable



Interior exterior

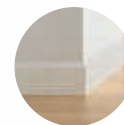

Sellado de rodapiés



Sellado de juntas



Sellado uniones tableros



Espuma poliuretano

- Espuma de expansión para sellado, relleno y fijación con propiedades aislantes.
- Excepcional adherencia sobre todo tipo de materiales.

Espuma de poliuretano 750ml, amarilla

Código	Acabado	Referencia	
25259	Cánula	EC750	12
25260	Pistola	EP750	12



Aislamiento marcos puertas y ventanas

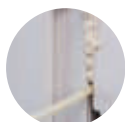

Juntas y uniones



Fontanería y electricidad



Limpiador de espuma de poliuretano 500ml

Código	Acabado	Referencia	
23284	Traslúcido	LESP-500	12



Uso manual



Uso pistola



Elimina espuma fresca en los equipos utilizados y endurecida en otras superficies

Masilla poliuretano

- Sellador monocomponente de módulo medio-alto de curado con la humedad atmosférica.
- Para todo tipo de materiales.

Masilla poliuretano N05 MASIFLEX 300ml

Código	Acabado	Referencia	
26652	Blanco	MASIFLEX	12
26653	Marrón	MASIFLEX	12
26654	Gris	MASIFLEX	12
26655	Negro	MASIFLEX	12



Elástico



Pintable



Interior exterior



Pegado elástico, tejas, zócalos...



Relleno de grietas y fisuras



Apto para pegado de cargas dinámicas

Masillas



Adhesivos y anclaje químico

Polímeros y adhesivos

Polímeros

- Adhesivo de nueva tecnología a base de polímeros modificados con silanos de alta calidad, extrafuerte, elástico, monocomponente, que cura por humedad, posee un alto módulo indicado para pegado elástico de la mayoría de los sustratos utilizados en la industria de la construcción, obra civil-residencial, astilleros, automoción, etc.

Polímero Power Tack TURBO. 290ml

Código	Acabado	Referencia	
26903	Blanco	P-TACK-01	12



Rápido Elástico Pintable Resistente rayos UV Aplicable en húmedo Interior exterior

Polímero CRISTAL. 290ml

Código	Acabado	Referencia	
26651	Transparente	P-CRISTAL	12



Elástico Pintable Resistente rayos UV Aplicable en húmedo Interior exterior



*Resistencia a la tracción
300kg./10cm2. (ISO 37)



*Resistencia a la tracción
200kg./10cm2. (ISO 37)

Adhesivo de montaje

- Adhesivo-fijador sintético con un gran agarre inicial, capaz de rellenar y pegar los más diversos sustratos con una gran rapidez y de forma sencilla.
- Ideal para todo tipo de fijaciones en la construcción, decoración, bricolaje...

Adhesivo de montaje. 290ml

Código	Acabado	Referencia	
26506	Blanco	ADH/M-01	12

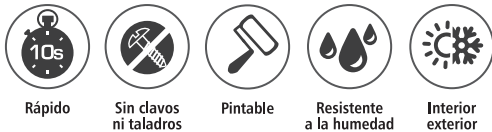

Adhesivo de cianocrilato y acelerante

- Excelente adhesivo, permite un agarre inmediato.
- Puede usarse para materiales porosos, MDF, madera y otros materiales.

Kit cianocrilato 50g + acelerador 200g

Código	Acabado	Referencia	
25539	Transparente	KIT/CIANO+ACE	24

Cianocrilato 50g

Código	Acabado	Referencia	
25540	Transparente	CIANO	50

Acelerador 200g

Código	Acabado	Referencia	
25541	Transparente	ACELERADOR	24



Cola blanca

- Cola vinílica, para uso general, de fácil aplicación y limpieza con agua, calidades D2.
- Alta adhesión y resistente a la humedad.
- Ideal para trabajos de ebanistería, montaje o ensamblaje en todo tipo de maderas, DM, aglomerado, HPL...

Cola blanca vinílica para madera D2

Código	Medida	Referencia	
21814	150g	CLV-B150D2	12
21815	250g	CLV-B250D2	12
21816	500g	CLV-B500D2	12
21820	750g	CLV-B750D2	16
21821	1Kg	CLV-B1KD2	18
21822	6Kg	CLV-B6KD2	4
21824	12Kg	CLV-B12KD2	1



Adhesivo universal de contacto

- Adhesivo de contacto sintético de tiempo abierto medio y buena resistencia a la temperatura.
- Excelente adhesión sobre numerosos materiales de construcción y decoración.
- Gran resistencia y poder de adhesivo final, así como rápido secado.

Adhesivo universal de contacto

Código	Medida	Referencia	
27894	250ml	ADHUC-250	12
27895	500ml	ADHUC-500	12
27896	1L	ADHUC-1L	18
27897	4L	ADHUC-4L	4
27898	20L	ADHUC-20L	1







Fuerte



Flexible



Multimaterial



Resistencia
60-70°



Cola en barra termofusible

- Barra de pegamento transparente, alta viscosidad, fabricada con materiales de alta calidad.
- Adecuada para pegar casi todos los materiales, como madera, papel, cartón, metal, textil, corcho, vidrio y plástico.

Cola en barra multiusos termofusible



Código	Medida	Referencia	
27886	12x200mm	COL-TERM12x200	10



Cinta adhesiva textil americana

- Buena adhesión en distintos tipos de superficies.
- Impermeable, de gran calidad, fija, repara, aísla y sella.

Cinta textil americana extrafuerte

Código	Medida	Referencia	Acabado	
27597	50mmx10m	CIN-AMER	Gris	24
27598	50mmx10m	CIN-AMER	Negro	24
27638	50mmx30m	CIN-AMER	Gris	24



100% impermeable



Interior exterior



50mm





250 micras

Cinta doble cara multiuso

- Multiuso, para colocación de moquetas, decoración y uniones temporales.
- Adhesivo extrafuerte.

Cinta doble cara multiuso

Código	Medida	Referencia	
27599	50mmx10m	CIN-DOBL	24



50mm



10m



Malla textil



170 micras

Cinta auto-vulcanizable

- Para la reparación de fugas de agua en mangueras y tuberías.
- Repara y aísla, posee un grosor de 0,75mm.

Cinta doble cara multiuso

Código	Medida	Referencia	
27577	9m	C-AS/9MX0,73	10



19mm



9m



Grosor 0,75mm

Cintas adhesivas y films

EXTRA FUERTE



Aísla y sella



Repara

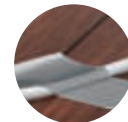

Fija

MULTIUSO

ADHESIVO EXTRA FUERTE

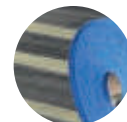

Adhesivo doble cara

AUTO-VULCANIZABLE



Repara y aísla

Cinta aislante PVC

- Proporciona aislamiento eléctrico.
- Acabado en negro y en blanco, de 20 y 30 metros de longitud.
- Certificado RoHS & REACH.



Cinta aislante PVC

Código	Grosor	Long.	Referencia	Acabado	
27305	0,15mm	20m	C-AS	Negro	10
27575	0,15mm	20m	C-AS	Blanco	10
27308	0,18mm	30m	C-AS	Negro	10
27576	0,18mm	30m	C-AS	Blanco	10

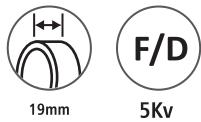

Cinta y film de embalar

Cinta embalaje PP solvente

Código	Anchura	Long.	Referencia	Acabado	
27200	48mm	63m	CEPPS-63	Transparente	36
27201	48mm	63m	CEPPS-63	Marrón	36
27209	48mm	126m	CEPPS-126	Transparente	36
27210	48mm	126m	CEPPS-126	Marrón	36

Cinta adhesiva de polipropileno solvente de gama alta, ideal para el cerrado de cajas de cartón y madera, así como todo tipo de aplicaciones de uso en general. Versátil y la más estable del mercado. La cinta PPS se caracteriza por un olor muy peculiar, fuerte y penetrante. Tiene un desenrollado ruidoso y es fácil de identificar.



Cinta embalaje PP acrílico

Código	Anchura	Long.	Referencia	Acabado	
27215	48mm	63m	CEPPA-63	Transparente	36
27216	48mm	63m	CEPPA-63	Marrón	36
27217	48mm	63m	CEPPA-63	Blanco	36
27218	48mm	126m	CEPPA-126	Transparente	36
27219	48mm	126m	CEPPA-126	Marrón	36
27220	48mm	126m	CEPPA-126	Blanco	36

Cinta adhesiva de polipropileno acrílico, ideal para el cerrado de cajas de cartón y materias plásticas. Cinta muy económica, ecológica (libre de disolventes) y muy versátil, cada vez más utilizada. La cinta PPA tiene un olor dulzón, más suave que el polipropileno solvente y un desenrollado más silencioso.



Cinta embalaje PVC

Código	Anchura	Long.	Referencia	Acabado	
27221	48mm	63m	CEPVC-63	Transparente	36
27222	48mm	63m	CEPVC-63	Marrón	36
27223	48mm	63m	CEPVC-63	Blanco	36
27224	48mm	126m	CEPVC-126	Transparente	36
27225	48mm	126m	CEPVC-126	Marrón	36
27226	48mm	126m	CEPVC-126	Blanco	36

Cinta adhesiva de PVC de alta calidad y resistencia, adecuada para todo tipo de cierres. El PVC es muy susceptible a los cambios de temperatura y, en especial, al frío, por lo que no se recomienda su uso en este tipo de condiciones. Es fácil de distinguir, porque es muy fácil cortarla con la mano y, a diferencia del polipropileno que se rasga al ser punzado, el PVC se agujerea sin rasgarse.



Film estirable manual

- Film estirable para paletizar y proteger sus palets de forma manual. Disponible en transparente, blanco y negro, nuestro film estirable se caracteriza por su polivalencia y alta resistencia al rasgado. Viene en bobinas de 50cm de ancho y 23 micras de espesor.

Film estirable manual para embalaje 50cm

Código	Medida	Referencia	Acabado	
27203	50cm/2Kg	FEM-50	Transparente	6
27204	50cm/2Kg	FEM-50	Negro	6
27212*	50cm/2Kg	FEM-50-100-2	Transparente	6
27213*	50cm/1,2Kg	FEM-50-100-1,2	Transparente	6



*Canuto 100gr.

Film MINI estirable manual para embalaje 10cm

Código	Medida	Referencia	Acabado	
27207	10cm/290g	FMM-10	Transparente	60



Aplicador film estirable

Código	Medida	Referencia	Acabado	
27206	---	A/FEM-50	Rojo/gris	1



Aplicador MINI-Film estirable

Código	Medida	Referencia	Acabado	
27208	---	A/FMM-10	Rojo/negro	1



Anclaje químico

Anclaje químico

- Resina poliéster sin estireno, de altas prestaciones.
- Certificado CE para hormigón no fisurado seco o mojado y mampostería sólida, hueca o perforada.
- También es adecuado como resina para reparación o resina adhesiva para componentes concretos.



Anclaje químico, gris hormigón

Código	Medida	Referencia	
24981	300ml	N05/AQP-E	12
25097	410ml	N05/AQP-E	12

Mixer mezclador para taco químico

Código	Acabado	Referencia	
24982	Blanco	N05/AQ/MX	1000

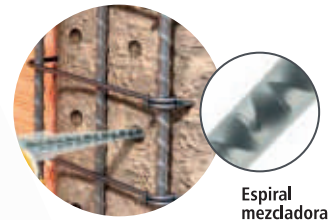

Espiral mezcladora

Tamiz de nylon para taco químico. M6/M8/M10

Código	Medida	Referencia	
24983	12x80mm	N05/AQ/TN	10
24984	16x85mm	N05/AQ/TN	10
24985	16x130mm	N05/AQ/TN	10



Ahorro de material y aumento de adherencia

LUBRICANTES Y GRASA INDUSTRIAL

Ferrotech, con los productos N05, tiene una amplia gama de lubricantes, antioxidantes y protectores contra el deterioro por uso y rozamiento de componentes metálicos de maquinaria, cerrajería... Aceites multiusos, con teflón, grafito, silicona en spray... son solo algunos de los lubricantes para determinados usos específicos que podrá encontrar en este catálogo.



Lubricantes y antioxidantes	140
Lubricantes en spray	140
Grasa industrial	142
Bomba de engrase	142



Lubricantes y antioxidantes

Lubricantes en spray

Aceite lubricante multiusos

Código	Medida	Referencia	
24939	200ml	NLUB01-200	12
24944	400ml	NLUB01-400	12



Lubrica



limpia



Antioxidante



Desbloquea

Aceite multiusos con TEFLÓN

- El spray multiusos con teflón lubrica y protege superficies. Gran capacidad antiadherente y alto poder anticorrosivo.
- Previene la congelación de partes de goma y la corrosión provocada por el agua salada. Impide cortocircuitos y el mal funcionamiento provocado por la humedad en los conductores eléctricos.

Aceite lubricante con teflón

Código	Medida	Referencia	
25111	400ml	NLUB02-400	12



Antihaderente



Anticorrosivo



Antioxidante



Lubrica



Especial Deportes

Aceite multiusos con GRAFITO

- El spray multiusos con grafito es la mejor solución frente a agarrotamientos de elementos mecánicos. Gracias a la presencia del grafito, se consigue un alto poder lubricante que reduce la fricción, oxidación y desgaste de las piezas, previniendo y eliminando chirridos metálicos.

Aceite lubricante con grafito especial cerrajería

Código	Medida	Referencia	
25112	400ml	NLUB03-400	12



Especial cerrajería

Grasa de litio

- Grasa en spray formulada para lubricar componentes que trabajan bajo duras condiciones mecánicas y grandes cadencias en la frecuencia de lubricación.

Grasa de litio

Código	Medida	Referencia	
25113	400ml	NLUB04-400	12



Antioxidante



Lubrica



Desbloquea

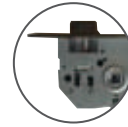

Protege al desgaste



Lubrica y protege los componentes de trabajos mecánicos



Silicona en spray

- Protege y conserva piezas de goma, plástico, bisagras, cerraduras, parachoques, cintas de transporte, instrumentos de precisión, cremalleras, etc., prolongando su vida. Es un lubricante eficaz y un agente antiadherente para que puertas, ventanas y otros elementos móviles con juntas de goma, puedan despegar con facilidad sin deteriorar los materiales o producir ruidos durante la separación.

Silicona en spray

Código	Medida	Referencia	
27093	400ml	SILS/400ML	12



Protege y conserva piezas de goma, plástico, bisagras, cerraduras, parachoques, cintas de transporte, instrumentos de precisión, cremalleras, etc.



Grasa consistente de litio

- La grasa de litio es un lubricante para maquinaria de trabajo pesado, cuya viscosidad le permite mantener su consistencia bajo condiciones extremas y llegar a lugares de difícil acceso para otros productos.

Grasa consistente de Litio en bote

Código	Medida	Referencia	
25114	1Kg	NGRA01-1K	12
25115	5Kg	NGRA01-5K	4
25116	20Kg	NGRA01-20K	1



Grasa consistente de Litio en cartucho

Código	Medida	Referencia	
25117	400gr	NGRA01-0,4K	28

·TEMPERATURAS TRABAJO: -25 a 135°C
 ·ACEITE PARAFÍNICO
 ·PENETRACIÓN 60 GOLPES 285
 ·PENETRACIÓN 10.000 G. 302



Grasa industrial

Especial para engrase general en la industria. Para todo tipo de mecanismos y rodamientos

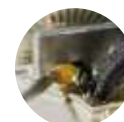

Bomba de engrase manual

- Bomba de engrase de diseño robusto con sistema de carga a granel por aspiración, con cartucho o dispensador. Sistema de sujeción de varilla antideslizante, con purgador y empuñadura de PVC. El diseño de tubo y pistón garantizan estanqueidad, sin desbordamiento de grasa.

Bomba de engrase 400CC, alta presión 10000PSI

Código	Medida	Referencia	
27574	400CC	BEN-400CC/10000	20



Para cartucho de 400g



690 Bar 10000 PSI



Manguera flexible 4 grapas

Conexión de accesorios M10



Bomba de engrase

QUÍMICOS PARA LIMPIEZA

Ferrotech le ofrece, a través de la marca N05, la mejor selección de productos de limpieza y desatros, de alta calidad y eficacia, ideales para uso profesional industrial y doméstico. Limpiadores e higienizantes en spray, limpiador de cemento, desengrasante... son algunos de los artículos que encontrará en las próximas páginas. Incluso, para su vehículo

06.2



Limpieza y desatros **144**

Limpiadores e higienizantes en spray 144

Limpiador de cemento 145

Desengrasante 145

Detergente hidrolimpiadoras 145



Limpeza y desatoros

Limpiadores e higienizantes en spray

Alcohol isopropílico

- Limpia y elimina profundamente la suciedad, higienizando todo tipo de superficies, evaporándose rápidamente y sin dejar residuos. Se puede utilizar para limpiar entornos domésticos, cepillos, teléfonos celulares o teléfonos inteligentes, ratones, teclados, monitores, ordenadores de sobremesa y portátiles, dispositivos electrónicos, como CD / DVD, cintas magnéticas, circuitos impresos. También se puede utilizar para limpiar dispositivos ópticos, como lentes, objetivos fotográficos y microscopios.

Alcohol isopropílico

Código	Medida	Referencia	
27177	400ml	AL-ISO400	12



Higieniza sin dejar residuos



Especial para componentes electrónicos



Indicado para lentes y materiales delicados

Tratamiento de cabina

- Producto diseñado para una acción de limpieza rápida, higiénica y efectiva del automóvil. Neutraliza olores desagradables de los asientos, plásticos y tapicería dentro del automóvil. Puede ayudar a eliminar el olor a tabaco e inmediatamente refresca e higieniza el ambiente.

Tratamiento higienizante para cabina de vehículo

Código	Medida	Referencia	
21991	150ml	SH-C150	12



Limpieza rápida, higiénica y efectiva del interior del automóvil



Neutraliza malos olores



Refresca e higieniza



Acción inmediata

Limpeza de cemento y residuos de la construcción

- Limpiador líquido para eliminar residuos de la construcción en distintas superficies, hormigoneras, maquinaria, moldes... limpieza de salitre en ladrillo visto.

Limpiador de cemento. Interior-exterio

Código	Medida	Referencia	
27635	1L	LIMP-CEM	20
27636	5L	LIMP-CEM	5

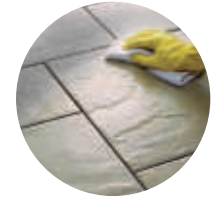

 Para un mejor resultado, dejar actuar unos minutos

Desengrasante líquido multiusos

- Limpiador multiusos de uso genérico. Se aplica donde haga falta una limpieza eficaz y rápida. Disuelve mugre, grasas, tanto vegetales como minerales, en superficies como azulejos, suelos, chimeneas, extractores de humo, etc.

Desengrasante multiusos K-7

Código	Medida	Referencia	
27633	1L	LIMP-DES/MUL	20
27634	5L	LIMP-DES/MUL	5



 Limpieza rápida y eficaz

Detergente para limpieza a presión

- Detergente para limpiadoras de alta presión. Facilita la eliminación de distintos tipos de suciedades en fachadas, azulejos y superficies metálicas sin dañarlas.

Detergente hidrolimpiadoras. Uso universal

Código	Medida	Referencia	
27631	1L	DE-HIDRO/UNI	20
27632	5L	DE-HIDRO/UNI	5



Detergente para limpiadoras de alta presión

Detergente hidrolimpiadoras

TREFILERÍA, TORNILLERÍA Y FIJACIONES

Ferrotech ofrece una selección de trefilería, tornillos y herramientas de fijación para industria y construcción, desde alambre, malla y cable galvanizados hasta todo tipo de tornillos, tacos de nylon y bridas, y remaches.



Trefilería 147

Alambre galvanizado 147

Malla galvanizada 148

Cable galvanizado 149

Eslingas, ratches y cintas de amarre 150

Eslingas 150

Ratches y cintas de amarre 151

Tornillería, cáncamos y alcayatas 152

Tornillos pozidrive y torx 152

Tornillos especiales 153

Alcayatas y cáncamos 155

Tacos nylon y bridas 156

Tacos nylon 156

Bridas 158

Remaches y fijaciones metálicas 159

Remaches 159

Ángulos, escuadras y palomillas 161



Trefilería

Alambre galvanizado

- Flexible y resistente para distintos usos, como industria, agricultura o residencial.
- Diferentes medidas.



Alambre galvanizado

Código	Medida	Referencia	
23120	Ø0,65mm-0,5kg	AGR01	5
23121	Ø0,65mm-1kg	AGR01	5
23122	Ø0,65mm-5kg	AGR01	5
23124	Ø0,75mm-0,5kg	AGR01	5
23125	Ø0,75mm-1kg	AGR01	5
23126	Ø0,75mm-5kg	AGR01	5
23128	Ø0,85mm-0,5kg	AGR01	5
23129	Ø0,85mm-1kg	AGR01	5
23130	Ø0,85mm-5kg	AGR01	5
23132	Ø0,95mm-0,5kg	AGR01	5
23133	Ø0,95mm-1kg	AGR01	5
23134	Ø0,95mm-5kg	AGR01	5
23136	Ø1,05mm-0,5kg	AGR01	5
23137	Ø1,05mm-1kg	AGR01	5
23138	Ø1,05mm-5kg	AGR01	5
23141	Ø1,15mm-0,5kg	AGR01	5
23142	Ø1,15mm-1kg	AGR01	5
23143	Ø1,15mm-5kg	AGR01	5
23145	Ø1,25mm-0,5kg	AGR01	5
23146	Ø1,25mm-1kg	AGR01	5
23147	Ø1,25mm-5kg	AGR01	5
23149	Ø1,35mm-0,5kg	AGR01	5

Alambre galvanizado



Alambre galvanizado

Código	Medida	Referencia	
23150	Ø1,35mm-1kg	AGR01	5
23151	Ø1,35mm-5kg	AGR01	5
23153	Ø1,45mm-0,5kg	AGR01	5
23154	Ø1,45mm-1kg	AGR01	5
23155	Ø1,45mm-5kg	AGR01	5
23157	Ø1,55mm-0,5kg	AGR01	5
23158	Ø1,55mm-1kg	AGR01	5
23159	Ø1,55mm-5kg	AGR01	5
23161	Ø1,70mm-0,5kg	AGR01	5
23162	Ø1,70mm-1kg	AGR01	5
23163	Ø1,70mm-5kg	AGR01	5
23165	Ø1,80mm-0,5kg	AGR01	5
23166	Ø1,80mm-1kg	AGR01	5
23167	Ø1,80mm-5kg	AGR01	5
23169	Ø1,95mm-0,5kg	AGR01	5
23170	Ø1,95mm-1kg	AGR01	5
23171	Ø1,95mm-5kg	AGR01	5
23173	Ø2,10mm-0,5kg	AGR01	5
23174	Ø2,10mm-1kg	AGR01	5
23175	Ø2,10mm-5kg	AGR01	5
23177	Ø2,30mm-0,5kg	AGR01	5
23178	Ø2,30mm-1kg	AGR01	5
23179	Ø2,30mm-5kg	AGR01	5
23181	Ø2,60mm-0,5kg	AGR01	5
23182	Ø2,60mm-1kg	AGR01	5
23183	Ø2,60mm-5kg	AGR01	5
23185	Ø2,95mm-0,5kg	AGR01	5
23186	Ø2,95mm-1kg	AGR01	5
23187	Ø2,95mm-5kg	AGR01	5
23189	Ø3,30mm-0,5kg	AGR01	5
23190	Ø3,30mm-1kg	AGR01	5
23191	Ø3,30mm-5kg	AGR01	5



Alambre galvanizado plastificado verde

Código	Medida	Referencia	
24686	20m	RAJ02	48
24687	100m	RAJ01	12

Alambre galvanizado plastificado

- Con revestimiento de PVC para su protección, perfecto para uso en jardín.
- Se caracteriza por su alta resistencia y flexibilidad.

Malla galvanizada

Malla galvanizada electrosoldada

Código	Luz	Ø	Referencia	
23779	6x6	0,7	MGE	1
23782	13x13	0,9	MGE	1
23786	16x16	1,2	MGE	1
23789	19x19	1,4	MGE	1
23792	25x25	1,6	MGE	1

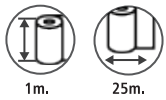
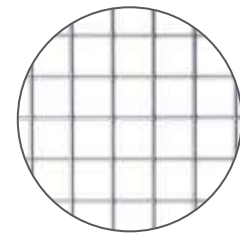

Malla galvanizada triple torsión

- Malla compuesta por alambres trenzados entre sí formando hexágonos.
- Ideal para cercados agrícolas y ganaderos.

Malla galvanizado triple torsión

Código	Luz	Ø	Referencia	
23795	13	0,7	MGT	1
23796	16	0,7	MGT	1
23799	19	0,7	MGT	1
23802	25	0,7	MGT	1
23805	31	0,8	MGT	1
23807	50	0,9	MGT	1

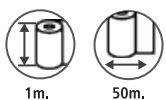
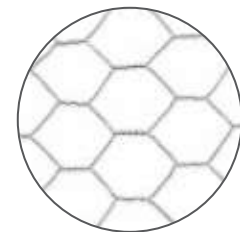

Cable galvanizado

- Alta resistencia, para uso general, especialmente indicado para trabajos como bricolage, mecanismos ligeros, tirantes, decoración, agricultura, etc.
- Varias longitudes y medidas disponibles.

Cable acero galvanizado. 6x7+FC. 1960N/mm²

Código	Medida	Rollo	Referencia	
20119	Ø2mm	25m	C-GAL1960N	1
20120	Ø3mm	25m	C-GAL1960N	1
20121	Ø4mm	25m	C-GAL1960N	1
20122	Ø5mm	25m	C-GAL1960N	1
20123	Ø6mm	25m	C-GAL1960N	1
27871	Ø8mm	25m	C-GAL1960N	1
<hr/>				
20124	Ø2mm	50m	C-GAL1960N	1
20125	Ø3mm	50m	C-GAL1960N	1
20126	Ø4mm	50m	C-GAL1960N	1
20127	Ø5mm	50m	C-GAL1960N	1
20128	Ø6mm	50m	C-GAL1960N	1
20134	Ø8mm	50m	C-GAL1960N	1
<hr/>				
20129	Ø2mm	100m	C-GAL1960N	1
20130	Ø3mm	100m	C-GAL1960N	1
20131	Ø4mm	100m	C-GAL1960N	1
20132	Ø5mm	100m	C-GAL1960N	1
20133	Ø6mm	100m	C-GAL1960N	1
20135	Ø8mm	100m	C-GAL1960N	1



Acero + zinc



Certificado EN12385-4



Núcleo de fibra



Estructura 6x7



Temperatura máxima



Flexibilidad moderada



Alta resistencia

Resistencia a la tracción: 1960N/mm²

Cable acero galvanizado. 6x19+FC. 1960N/mm²

Código	Medida	Rollo	Referencia	
27872	Ø10mm	25m	C-GAL1960N	1
27873	Ø12mm	25m	C-GAL1960N	1
20136	Ø10mm	50m	C-GAL1960N	1
27874	Ø12mm	50m	C-GAL1960N	1
20137	Ø10mm	100m	C-GAL1960N	1
27875	Ø12mm	100m	C-GAL1960N	1



Acero + zinc



Certificado EN12385-4



Núcleo de fibra



Estructura 6x19



Temperatura máxima



Flexibilidad moderada



Alta resistencia

Resistencia a la tracción: 1960N/mm²

Cable galvanizado

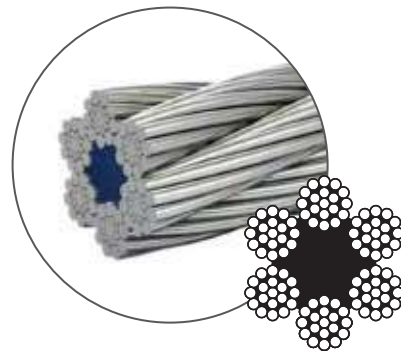
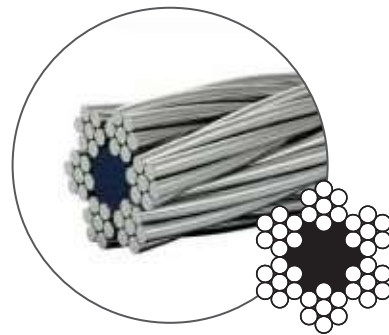



Eslingas, ratches y cintas de amarre

Eslingas

Eslinga plana

- Con revestimiento de PVC para su protección, perfecto para uso en jardín.
- Se caracteriza por su alta resistencia y flexibilidad.

Eslinga plana gazas reforzadas 2T

Código	Medida	Referencia	
27921	2m	EP2T-2M	1
27922	3m	EP2T-3M	1
27923	4m	EP2T-4M	1
27924	6m	EP2T-6M	1



2
Toneladas



Gazas
reforzadas



Certificado
EN-1492-1



Eslinga plana gazas reforzadas 3T

Código	Medida	Rollo	Referencia	
27925	2m	25m	EP3T-2M	1
27926	3m	25m	EP3T-3M	1
27927	4m	25m	EP3T-4M	1
27928	6m	25m	EP3T-6M	1



3
Toneladas



Gazas
reforzadas



Certificado
EN-1492-1



Ratche. Cinta con trinquete

- Alta resistencia, para uso general, especialmente indicado para trabajos como bricolage, mecanismos ligeros, tirantes, decoración, agricultura, etc.
- Varias longitudes y medidas disponibles.

Ratche. Cinta con trinquete

Código	Medida (A+B)	Ancho		Referencia	
27929	5m (4,7+0,3m)	25mm	1T	RACH/C1T-5M	1
27930	6m (5,6+0,4m)	35mm	2T	RACH/C2T-6M	1
27931	7m (6,6+0,4m)	35mm	3T	RACH/C3T-7M	1
27932	8m (7,5+0,5m)	50mm	4T	RACH/C4T-8M	1



Certificado EN-12195-2

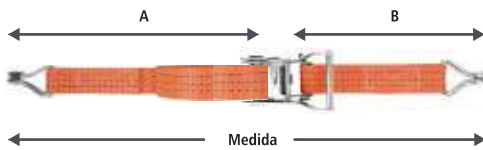

Cinta de amarre

- Alta resistencia, para uso general, especialmente indicado para trabajos como bricolage, mecanismos ligeros, tirantes, decoración, agricultura, etc.
- Varias longitudes y medidas disponibles.

Cinta de amarre con hebilla

Código	Medida	Ancho	Referencia	
27933	2m	25mm	CAH/250-2M	1
27934	4m	25mm	CAH/250-4M	1
27935	6m	25mm	CAH/250-6M	1



250kg



Tornillería, alcayatas y cáncamos

Tornillos pozidrive y torx

Tornillos pozidrive rosca madera

- Para uniones de todo tipo entre maderas. También para taco de nylon.
- Acabado bicromatado y cincado.
- Cabeza plana.

Tornillos pozidrive rosca madera, cabeza plana

Bicromatado

Código	Medida	Referencia	
20875	2,5x20mm	0901/2,5x20	1000
20880	3,0x16mm	0901/3,0x16	1000
20317	3,0x20mm	0901/3,0x20	1000
20883	3,0x30mm	0901/3,0x30	1000
20320	3,5x16mm	0901/3,5x16	1000
20321	3,5x20mm	0901/3,5x20	1000
20322	3,5x25mm	0901/3,5x25	1000
20323	3,5x30mm	0901/3,5x30	1000
20324	3,5x35mm	0901/3,5x35	1000
20325	3,5x40mm	0901/3,5x40	1000
20890	3,5x45mm	0901/3,5x45	1000
20287	3,5x50mm	0901/3,5x50	1000
20893	4,0x16mm	0901/4,0x16	1000
20896	4,0x20mm	0901/4,0x20	1000
20326	4,0x30mm	0901/4,0x30	1000
20327	4,0x40mm	0901/4,0x40	1000
20328	4,0x45mm	0901/4,0x45	1000
20288	4,0x50mm	0901/4,0x50	500
20329	4,0x60mm	0901/4,0x60	500
20330	4,0x70mm	0901/4,0x70/42	500
20331	4,5x30mm	0901/4,5x30	500
20906	4,5x35mm	0901/4,5x35	500
20332	4,5x40mm	0901/4,5x40	500
20334	4,5x50mm	0901/4,5x50	500
20335	4,5x60mm	0901/4,5x60	200
20908	4,5x70mm	0901/4,5x70/42	200
20336	5,0x50mm	0901/5,0x50	200
20918	5,0x60mm	0901/5,0x60	200
20919	5,0x70mm	0901/5,0x70/42	200
20337	5,0x80mm	0901/5,0x80/48	200
20920	5,0x90mm	0901/5,0x90/54	200
20338	5,0x100mm	0901/5,0x100/60	200

Tornillo pozidrive rosca madera, cabeza plana

Cincado

Código	Medida	Referencia	
20316	3,0x16mm	0901/3,0x16	1000
21339	3,5x13mm	0901/3,5x13	1000
20558	3,5x15mm	0901/3,5x15	1000
21263	3,5x16mm	0901/3,5x16	1000
21266	3,5x20mm	0901/3,5x20	1000
20341	3,5x25mm	0901/3,5x25	1000
20342	3,5x30mm	0901/3,5x30	1000
21267	3,5x35mm	0901/3,5x35	1000
21269	3,5x45mm	0901/3,5x45	1000
21270	3,5x50mm	0901/3,5x50	1000
21276	4,0x20mm	0901/4,0x20	1000
21314	5,0x70mm	0901/5,0x70/42	200
21315	5,0x80mm	0901/5,0x80/48	200
21316	5,0x90mm	0901/5,0x90/54	200

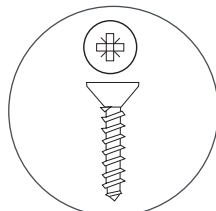

Tornillo torx rosca madera, cabeza plana

Bicromatado

Código	Medida	Referencia	
21348	6,0x70/42mm	0907/6,0x70/42	200
21349	6,0x80/48mm	0907/6,0x80/48	200
21350	6,0x90/54mm	0907/6,0x90/54	200
22926	6,0x60mm	0907/6,0x60	200



Torx



Cabeza plana



Rosca madera

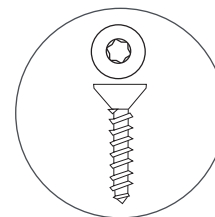

Tornillos torx rosca madera-punta broca

- Cabeza plana y estriada, rosca helicoidal para madera, punta broca.
- Acabado bicromatado, varias medidas.

Tornillos torx, cabeza plana, doble rosca: helicoidal, roscamadera y punta broca

Bicromatado

Código	Medida	Referencia	
22927	6,0x100/60mm	0907B/6,0x100/60	100
22928	6,0x120/75mm	0907B/6,0x120/75	100
22929	6,0x140/75mm	0907B/6,0x140/75	100
22930	6,0x160/75mm	0907B/6,0x160/75	100
22931	6,0x180/75mm	0907B/6,0x180/75	100
22932	6,0x200/75mm	0907B/6,0x200/75	100
22933	6,0x220/75mm	0907B/6,0x220/75	100
25467	8,0x200/80mm	0907B/8,0x200/80	100
27741	8,0x220/80mm	0907/8,0x220/80	100
25468	8,0x240/80mm	0907B/8,0x240/80	100
25469	8,0x260/80mm	0907B/8,0x260/80	100
25470	8,0x300/80mm	0907B/8,0x300/80	100



Torx



Cabeza plana



Cabeza estriada mejor avellanado



Rosca helicoidal



Punta broca



Rosca madera

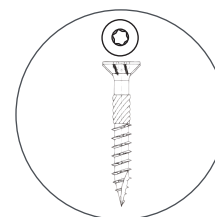

Tornillos especiales

CERTIFICADO ISO 9002

Tornillo autocortante combi

- Cabeza combi (estrella y plano), pieza autocortante.
- Acabado bicromatado y cincado.

Tornillo autocortante y cabeza combi

Código	Medida	Referencia		Acabado
21589	4,0x45mm	0911/4,0x45	3500	Bicromatado
21407	4,0x45mm	0911/4,0x45	3500	Cincado



Combi



Autocortante

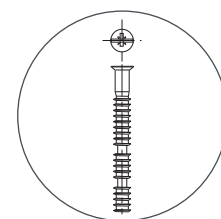

Tornillos ensablaje allen

- Tornillo allen, rosca madera.
- Acabado bicromatado, cincado y pavonado.

Tornillos ensablaje, cabeza allen y rosca madera

Código	Medida	Acabado	Referencia		Acabado
22038	5,0x50mm	Bicromatado	0904/5,0x50	3000	Bicromatado
20289	5,0x50mm	Cincado	0904/5,0x50	3000	Cincado
22036	5,0x50mm	Pavonado	0904/5,0x50	3000	Pavonado
22039	7,0x50mm	Bicromatado	0904/7,0x50	2500	Bicromatado
20290	7,0x50mm	Cincado	0904/7,0x50	2500	Cincado
22037	7,0x50mm	Pavonado	0904/7,0x50	2500	Pavonado



Allen



Rosca
madera

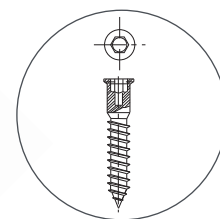

Alcayata roscada

- Útiles para colgar lo que deseemos en la pared de forma rápida y sencilla.
- Cincada, varias medidas.

Alcayata rosca cincada

Código	Medida	Galga	
20003	2,0x20/8mm	16x30	500
20004	2,5x30/10mm	17x40	200
20007	3,0x35/12mm	18x50	200
20010	3,3x35/15mm	19x60	200
20011	3,3x51/18mm	19x70	200
20012	4,0x35/12mm	20x50	200
20013	4,0x45/16mm	20x60	200
20014	4,0x51/19mm	20x70	200
20015	4,0x60/20mm	20x80	200
20016	4,3x70/32mm	20x90	200
20023	4,85x80/25mm	22x100	100
20024	4,85x102/38mm	22x120	100

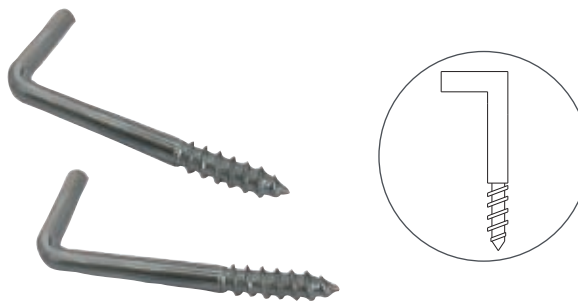

Alcayatas y cáncamos

Cáncamo roscado

- Perfectos para paredes, vigas, para soportar tensiones horizontales y colgar y elevar objetos.
- Abierto y cerrado, cincados, varias medidas.

Cáncamo abierto cincado

Código	Medida	Galga	
20025	1,8x21/7mm	14x25	1000
20027	2,0x23/8mm	16x30	1000
20028	2,5x29/8mm	17x40	500
20030	3,0x35/12mm	18x50	200
20032	3,3x39/15mm	19x60	200
20035	3,7x47/15mm	20x70	200
20036	4,0x53/19mm	20x80	200
20037	4,0x60/19mm	20x90	200
20042	4,3x63/20mm	21x100	100
20044	4,85x73/25mm	22x110	100
20045	4,85x90/30mm	22x120	100

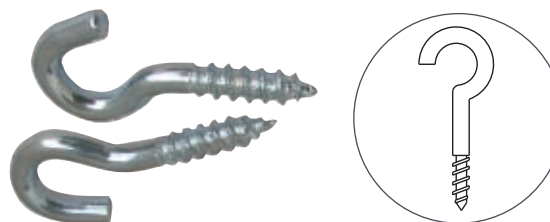

Cáncamo cerrado cincado

Código	Medida	Galga	
20046	1,8x22/6mm	14x25	1000
20048	2,0x23/8mm	16x30	1000
20049	2,5x30/10mm	17x40	500
20051	3,0x36/12mm	18x50	500
20053	3,3x40/15mm	19x60	200
20057	4,0x45/16mm	20x70	200
20058	4,0x52/16mm	20x80	200
25754	4,0x62/20mm	20x90	200
20063	4,3x65/20mm	21x100	100
25753	4,3x76/25mm	21x110	100
20066	4,85x75/32mm	22x120	100





Tacos nylon y bridas

Tacos nylon

Taco estriado blanco

- Indicado para realizar fijaciones. Estriado, con acabado blanco, para tornillos.
- Varias medidas.

Taco estriado blanco (p.x100)

Código	Medida	Referencia	
24704	Ø5mm	TN05	25
24705	Ø6mm	TN05	25
24706	Ø7mm	TN05	25
24707	Ø8mm	TN05	25
24708	Ø9mm	TN05	25
24709	Ø10x34mm	TN05	25
24710	Ø10x40mm	TN05	25
24711	Ø10x50mm	TN05	25
24712	Ø12mm	TN05	25



Taco nylon estándar

- Indicado para realizar fijaciones ligeras en materiales macizos, como hormigón, piedra, ladrillos macizos. Acabado gris.
- Sus alas laterales permiten ejercer un rozamiento en el agujero que evita que el taco gire sobre sí mismo. Varias medidas.

Taco nylon gris ESTÁNDAR (p.x100)

Código	Medida	Referencia	
24172	4x20mm	TN01	200
24173	5x25mm	TN01	200
24174	6x30mm	TN01	100
24175	7x35mm	TN01	100
24176	8x40mm	TN01	100
24177	10x50mm	TN01	50
24178	10x60mm	TN01	50
24179	12x60mm	TN01	25
24180	14x75mm	TN01	20
24181	16x90mm	TN01	10
24182	16x100mm	TN01	10
24183	16x120mm	TN01	10
24184	16x140mm	TN01	10



Taco nylon universal

- Con reborde, que impide que el conector se deslice al interior del agujero, permitiendo así una sencilla instalación.
- Varias medidas.

Taco nylon gris UNIVERSAL SX (p.x100)

Código	Medida	Referencia	
24185	5x25mm	TN02	200
24186	6x30mm	TN02	100
24187	8x40mm	TN02	100
24188	10x50mm	TN02	50
24189	12x60mm	TN02	25



Taco clavo nylon

- Adecuado para hormigón y materiales de albañilería, desde ladrillo perforado hasta placas para construcción ligera.
- Acabado gris con cuello avellanado.

Taco clavo N nylon gris cuello avellanado (p.x100)

Código	Medida	Referencia	
24388	5x25mm	TN03-AV	200
24389	5x35mm	TN03-AV	100
24390	5x45mm	TN03-AV	100
24391	6x35mm	TN03-AV	100
24392	6x40mm	TN03-AV	100
24393	6x45mm	TN03-AV	100
24394	6x55mm	TN03-AV	100
24395	6x60mm	TN03-AV	50
24396	6x70mm	TN03-AV	50
24397	6x80mm	TN03-AV	50
24398	8x45mm	TN03-AV	50
24399	8x60mm	TN03-AV	50
24400	8x75mm	TN03-AV	50
24401	8x80mm	TN03-AV	50
24402	8x100mm	TN03-AV	50
24403	8x120mm	TN03-AV	50
24404	8x135mm	TN03-AV	50



Taco nylon pladur

- Al introducirse en los espacios huecos se expande y permite un perfecto agarre en este tipo de superficies.
- También con alas, en diferentes medidas, según necesidad.

Taco nylon blanco para pladur (p.x100)

Código	Medida	Referencia	
24207	10x35mm	TN04	100



Taco nylon blanco ALAS para pladur (p.x100)

Código	Medida	Referencia	
20071	8x35mm	TN06	50
20072	8x42mm	TN06	50
20073	10x38mm	TN06	50
20074	10x47mm	TN06	50



Bridas

Brida de nylon poliamida

● Negro

Código	Medida	Referencia	
20188	2,5x100mm	BDNF-N	100
20189	2,5x140mm	BDNF-N	100
20190	2,5x160mm	BDNF-N	100
20191	3,6x140mm	BDNF-N	100
20192	3,6x200mm	BDNF-N	100
20193	3,6x250mm	BDNF-N	100
20194	3,6x300mm	BDNF-N	100
20195	3,6x370mm	BDNF-N	100
20196	4,8x200mm	BDNF-N	100
20197	4,8x250mm	BDNF-N	100
20198	4,8x300mm	BDNF-N	100
20199	4,8x400mm	BDNF-N	100
20200	7,6x400mm	BDNF-N	100
20201	7,6x450mm	BDNF-N	100
20202	7,6x550mm	BDNF-N	100
20203	8,8x750mm	BDNF-N	100
20204	9,0x920mm	BDNF-N	100

Brida de nylon poliamida

○ Blanco

Código	Medida	Referencia	
20293	2,5x100mm	BDNF-B	100
20294	2,5x140mm	BDNF-B	100
20295	2,5x160mm	BDNF-B	100
20296	3,6x140mm	BDNF-B	100
20297	3,6x200mm	BDNF-B	100
20298	3,6x250mm	BDNF-B	100
20299	3,6x300mm	BDNF-B	100
20300	3,6x370mm	BDNF-B	100
20301	4,8x200mm	BDNF-B	100
20302	4,8x250mm	BDNF-B	100
20303	4,8x300mm	BDNF-B	100
20304	4,8x400mm	BDNF-B	100

Brida de nylon poliamida

● Verde

Código	Medida	Referencia	
20771	2,5x100mm	BDNF-V	100
20772	3,6x140mm	BDNF-V	100
20773	3,6x200mm	BDNF-V	100
20774	4,8x300mm	BDNF-V	100

Taco brida Ø8mm

● Negro

Código	Medida	Referencia	
20205	8mm	T-BDNF-N	100

Bridas nylon

- Ideal para atar cables, mangueras, ramales..., de forma rápida, fácil y fiable.
- En varias medidas y acabados (negro, blanco y verde).

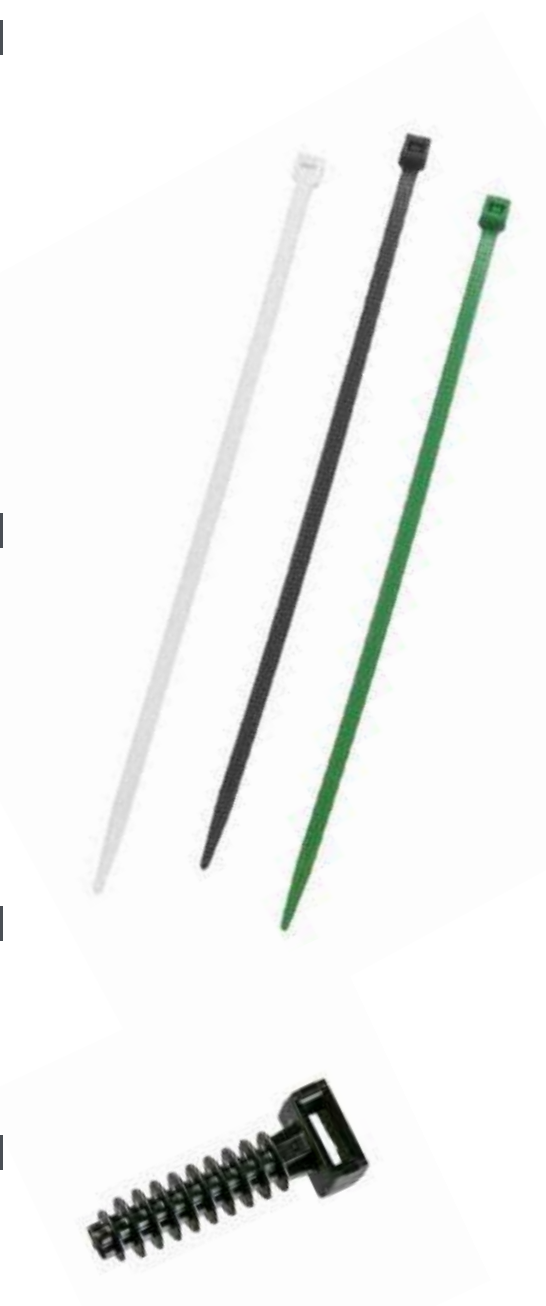







Remaches y fijaciones metálicas

Remaches aluminio y acero

- Con cabeza alomada, cuerpo de aluminio y clavo de acero.
- El remachado se realiza por un solo lado y garantiza una fijación sólida y segura, sea cual sea el material de la pieza.

Remache estándar, cabeza alomada, cuerpo de aluminio y clavo de acero

Código	dxL	Referencia	 mm		Fuerza máx.
27742	3,2x6	13206	1,5/3,5	1000	 980N  760N  Ø 3,3mm d 3,2mm D= 6,3mm S= 1,0mm
27743	3,2x8	13208	3,5/5,0	1000	
27744	3,2x10	13210	5,0/7,0	1000	
27745	3,2x12	13212	7,0/9,0	1000	
27746	3,2x14	13214	9,0/11,0	1000	
27747	3,2x16	13216	11,0/13,0	1000	
27748	4,0x6	13806	1,5/3,0	1000	 Ø 4,1mm d 4,0mm D= 8,0mm S= 1,3mm
27749	4,0x8	13808	3,0/5,0	1000	
27750	4,0x10	13810	5,0/6,5	1000	
27752	4,0x12	13812	6,5/8,5	500	
27753	4,0x14	13814	8,5/10,5	500	
27755	4,0x16	13816	10,5/12,5	500	
27756	4,0x18	13818	12,5/14,5	500	
27758	4,0x20	13820	14,5/16,5	500	
27760	4,8x6	14806	1,5/2,5	500	 Ø 4,9mm d 4,8mm D= 9,5mm S= 1,4mm
27761	4,8x8	14808	2,5/4,0	500	
27762	4,8x10	14810	4,0/6,0	500	
27763	4,8x12	14812	6,0/8,0	500	
27764	4,8x14	14814	8,0/10,0	500	
27765	4,8x16	14816	10,0/12,0	500	
27766	4,8x18	14818	12,0/14,0	500	
27767	4,8x20	14820	14,0/16,0	500	
27768	4,8x25	14825	18,0/21,0	500	



Cabeza alomada







Cuerpo aluminio



Clavo acero

Remache estándar, cabeza ancha D12, cuerpo de aluminio y clavo de acero

Código	dxL	Referencia	 mm		Fuerza máx.
27751	4,0x10	33810	5,0/6,5	500	 1600N  1200N  Ø 4,1mm d 4,0mm D= 12,0mm S= 1,5mm
27754	4,0x14	33814	8,5/10,5	500	
27757	4,0x18	33818	12,5/14,5	500	
27759	4,0x24	33824	18,5/22,0	500	



Cabeza ancha D12



Cuerpo aluminio



Clavo acero

Remaches

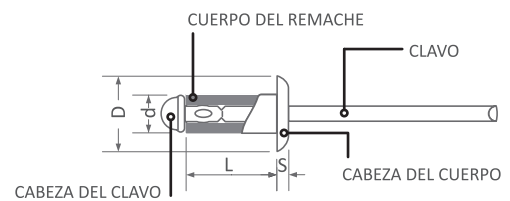

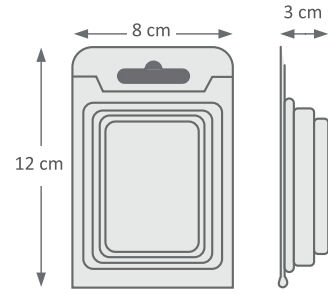
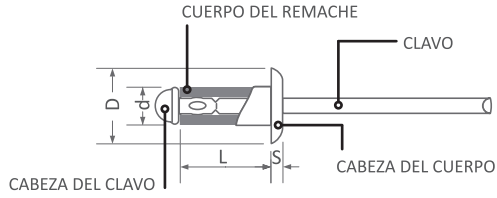

Blíster remache estándar, cabeza alomada, cuerpo de aluminio y clavo de acero

Código	dxL	Referencia	mm			Fuerza máx.	
27769	3,2x6	X0013206	1,5/3,5	120	10	 980N 760N	Ø 3,3mm d 3,2 mm D= 6,3mm S= 1,0mm
27770	3,2x8	X0013208	3,5/5,0	100	10		
27771	3,2x10	X0013210	5,0/7,0	100	10		
27772	3,2x12	X0013212	7,0/9,0	100	10		
27773	3,2x14	X0013214	9,0/11,0	100	10		
27774	4,0x6	X0013806	1,5/3,0	80	10	 1600N 1200N	Ø 4,1mm d 4,0 mm D= 8,0mm S= 1,3mm
27775	4,0x8	X0013808	3,0/5,0	70	10		
27776	4,0x10	X0013810	5,0/6,5	70	10		
27777	4,0x12	X0013812	6,5/8,5	65	10		
27778	4,0x14	X0013814	8,5/10,5	65	10		
27779	4,8x6	X0014806	1,5/2,5	60	10	 2230N 1690N	Ø 4,9mm d 4,8 mm D= 9,5mm S= 1,4mm
27780	4,8x8	X0014808	2,5/4,0	60	10		
27781	4,8x10	X0014810	4,0/6,0	50	10		
27782	4,8x12	X0014812	6,0/8,0	45	10		
27783	4,8x14	X0014814	8,0/10,0	45	10		



Blíster remache estándar, cabeza ancha D12, cuerpo de aluminio y clavo de acero

Código	dxL	Referencia	mm			Fuerza máx.	
27784	4,0x12	X0033812	5,0/6,5	40	10	 1600N 1200N	Ø 4,1mm d 4,0 mm D= 12,0mm S= 1,5mm
27785	4,0x16	X0033816	8,5/10,5	30	10		
27786	4,0x20	X0033820	12,5/14,5	25	10		



Blíster remache, cabeza ancha, D14, alu/ace

Código	dxL	Referencia	mm			Fuerza máx.	
27787	4,8x8	X0034808	2,5/4,0	35	10	 1600N 1200N	Ø 4,9mm d 4,8 mm D= 14,0mm S= 1,6mm
27788	4,8x12	X0034812	6,0/8,0	25	10		
27789	4,8x16	X0034816	10,0/12,0	25	10		
27790	4,8x20	X0034820	14,0/16,0	20	10		



Ángulos y escuadras

- De refuerzo, canto redondo.
- Bicromatados, varias medidas.

Ángulo fijo, bicromatado

Código	Medida (AxH)	Referencia	
23663	20x2mm	A-20	100
23662	30x2mm	A-30	100
23661	40x2mm	A-40	100
23660	50x2mm	A-50	100
23659	60x2,4mm	A-60	100
23658	80x2,4mm	A-80	50
23657	100x2,4mm	A-100	50

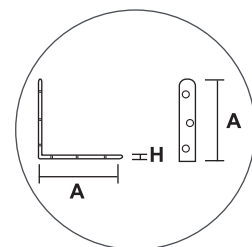

Escuadra fija, bicromatada

Código	Medida	Referencia	
23656	40x12x1mm	E-40	100
23655	50x14x1mm	E-50	100
23654	60x15x1mm	E-60	100
23653	80x17x1,2mm	E-80	100
23652	100x17x1,2mm	E-100	50
23651	120x17x1,2mm	E-120	50

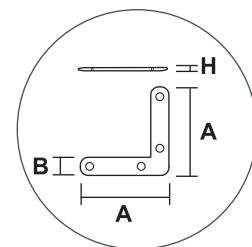

Palomillas

- Soporte estantería pared, soporte balda pared. Acabado en blanco.

Palomilla fija reforzada para balda de madera, acabado blanco

Código	Medida AxBxC	Referencia	
22787	100x75x0,8	HMU016	24
22041	125x100x0,8	HMU016	24
22042	125x150x0,8	HMU016	24
22043	150x200x0,8	HMU016	24
22044	200x250x0,8	HMU016	24
22045	250x300x1,0	HMU016	24
22046	300x350x1,0	HMU016	24
24135	350x400x1,0	HMU016	12
24136	400x450x1,0	HMU016	12

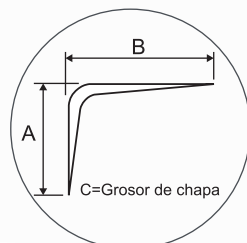
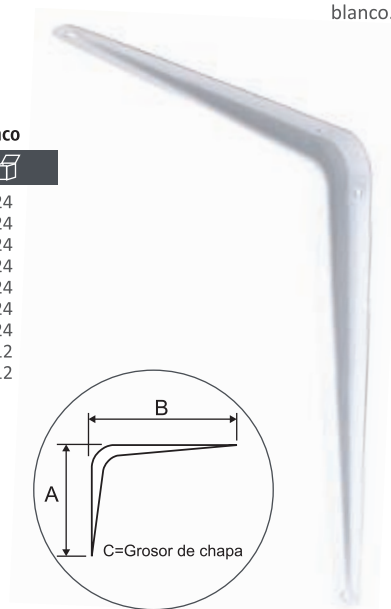

PODA Y JARDÍN

Qué importante es mantener tu jardín o huerto en perfectas condiciones. Por eso, Ferrotech ofrece una amplia gama de herramientas y utensilios para este menester, entre mangueras y accesorios de riego, pulverizadores y fumigación, útiles para poda y limpieza, mallas de protección y delimitación, accesorios y maquinarias, y artículos de protección. En definitiva, todo lo que necesitas para cuidar la vegetación de tu propiedad.

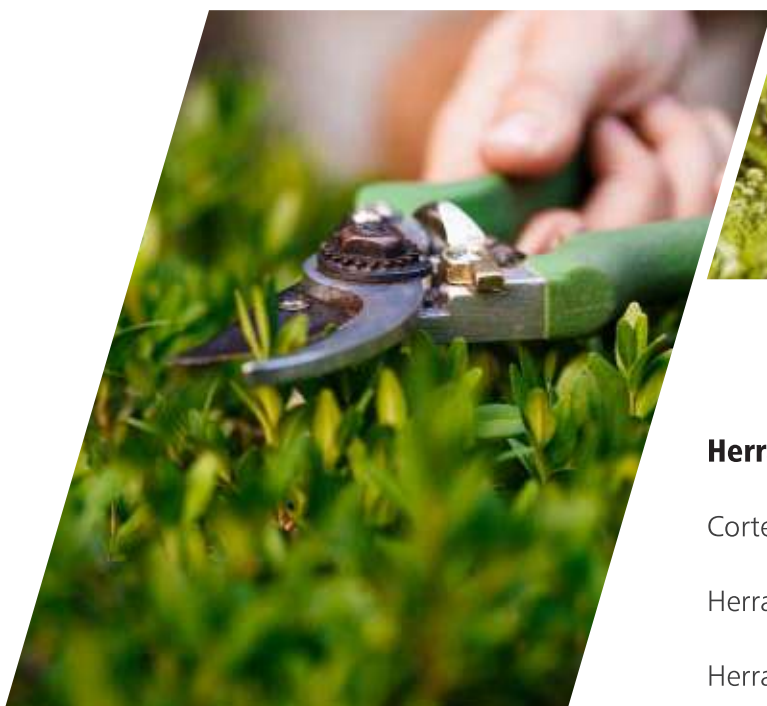

Herramienta de poda y jardín **178**

Corte y poda	178
Herramienta de jardín	182
Herramienta para limpieza	183
Mallas de protección y delimitación	185

Accesorios maquinaria jardinería **186**

Accesorios desbrozadora	186
Accesorios motosierra	188
Protección y seguridad	189

Toldos de exterior **190**

Toldos de polietileno	190
-----------------------	-----

Mangueras y accesorios de riego **163**

Mangueras y complementos	163
Accesorios de riego	167

Pulverizadores y fumigación **175**

Pulverizadores automáticos	175
Pulverizadores manuales	176



Mangueras y accesorios de riego

Mangueras y complementos

Manguera antitorsión, 4 capas: PVC int., antialgas, malla tricotada antitorsión y PVC ext. anti UV

Código	Medida	ØInterior	Referencia	
25091	15m	15mm	MNT15-15M	1
24774	25m	15mm	MNT15-25M	1
24775	50m	15mm	MNT15-50M	1
25092	15m	19mm	MNT19-15M	1
24776	25m	19mm	MNT19-25M	1
24777	50m	19mm	MNT19-50M	1



Antitorsión



Anti UV



No tóxico



Antialgas



10/12 bar



10 ANOS
GARANTÍA

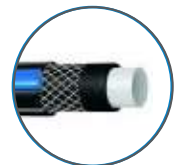

4capas

Kit rápido: dos conectores, adaptador y boquilla.
Manguera antitorsión, 4 capas

Código	Medida	ØInterior	Referencia	
25093	15m	15mm	KIT-MNT15-15M	1
25094	25m	15mm	KIT-MNT15-25M	1
25095	15m	19mm	KIT-MNT19-15M	1
25096	25m	19mm	KIT-MNT19-25M	1



Antitorsión



Anti UV



No tóxico



Antialgas



10/12 bar



10 ANOS
GARANTÍA

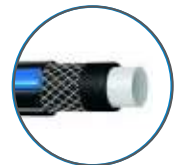

4capas

4
PZAS

INCLUYE:
2 conectores
1 adaptador
1 boquilla



Manguera PLUS 5 capas doble malla

Código	Medida	ØInterior	Referencia	
20445	25m	15mm	PLUS15-25M	1
20446	50m	15mm	PLUS15-50M	1
20447	25m	19mm	PLUS19-25M	1
20448	50m	19mm	PLUS19-50M	1



Antitorsión



Anti UV



No tóxico



Antialgas



20 bar



Plástico alimentario en capa interior



Libre de cadmio y plomo

Manguera latex malla trenzada, 3 capas

Código	Medida	ØInterior	Referencia	
27189	15m	15mm	LATEX15-15M	1
20449	25m	15mm	LATEX15-25M	1
20450	50m	15mm	LATEX15-50M	1
20451	25m	19mm	LATEX19-25M	1
20452	50m	19mm	LATEX19-50M	1



Muy flexible



Anti UV



No tóxico



Antialgas



10 bar



Libre de cadmio y plomo

Manguera látex sin malla

Código	Medida	ØInterior	Referencia	
27183	25m	15mm	LATEX/SM15-25M	1
27184	50m	15mm	LATEX/SM15-50M	1
27185	25m	19mm	LATEX/SM19-25M	1
27186	50m	19mm	LATEX/SM19-50M	1
27187	25m	25mm	LATEX/SM25-25M	1
27188	50m	25mm	LATEX/SM25-50M	1



Anti UV



No tóxico



Antialgas



4 bar



Libre de cadmio y plomo

Manguera extensible, interior de plástico elástico (TPR) y exterior de poliéster, duplica su tamaño

Código	Medida	Acabado	Referencia	
26533	10m-20m	Verde	MAN-EXT-01	1

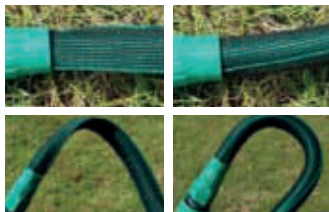

Kit de riego con pistola multifunción, conectores y manguera espiral 15 m.

Código	Acabado	Referencia	
24331	Verde/negro	KRM01	6

7
Posiciones

Chorro
Cono
Centrado
Plano
Ducha
Presión
Nebulizado



4
PZAS

INCLUYE:
1 pistola 7 posiciones.
2 conectores.
1 manguera espiral 15m.

Manguera PVC transparente HQ

Código	Medida	Ø	Referencia	
24166	50m	8-10	MC2-50	1
24168	50m	10-12	MC4-50	1
24169	50m	10-14	MC5-50	1
24170	50m	12-15	MC6-50	1
24171	50m	15-20	MC7-50	1



Soportes mangueras

- Para organizar y recoger las mangueras tras su instalación en la pared.
- Realizados en plástico resistente.

Colgador plástico de pared para manguera

Código	Medida	Referencia	
24334	--	CMP	1



Colgador plástico de pared para manguera, mod. Clásico

Código	Medida	Referencia	
24690	--	CMP02	1



Carro para mangueras

- Realizado en metal y plástico, con agarre de PVC.
- Fácil y cómodo de transportar por todo el jardín.

Carro para manguera

Código	Medida	Referencia	
27298	-	HPJ30	1



Manivela para enrollar



2 ruedas para fácil desplazamiento



Agarre de PVC

60
metros

Capacidad manguera 1/2"

45
metros

Capacidad manguera 5/8"

Carrete para manguera

Código	Medida	Referencia	
27299	-	HPJ31	1



Manivela para enrollar



Agarre de PVC

60 metros

Capacidad manguera 1/2"

45 metros

Capacidad manguera 5/8"



Accesorios de riego de latón

- Realizados en latón de alta calidad, a prueba de herrumbre y construcción de latón sólido para garantizar que los accesorios de la manguera de jardín no se oxiden ni se corroan fácilmente.
- Las juntas de goma evitan eficazmente las fugas de agua.

 Larga vida útil

 Conexión hermética

Conector latón simple

Código	Referencia	
27119	CL-S	12

Fácil de conectar, garantiza una conexión hermética. Para unir fácilmente dos mangueras usando dos conectores de manguera.

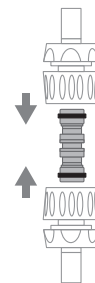

Conector latón triple

Código	Referencia	
27120	CL-T	12

Fácil de conectar, garantiza una conexión hermética. Para unir fácilmente tres mangueras usando tres conectores de manguera.

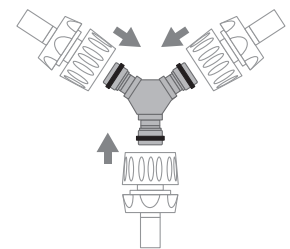

Adaptador latón 2 vías 3/4" con válvula

Código	Medida	Referencia	
27121	3/4"	AL2-3/4	12

Adaptador grifo-manguera doble con válvulas independientes. Se puede conectar con grifos de 3/4".

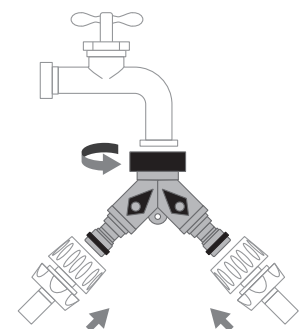

Accesorios de riego

Adaptador latón grifo-manguera hembra engomado

Código	Medida	Referencia	
27122	1"	AGM-1	12
27123	3/4"	AGM-3/4	12

Fácil de conectar garantiza una conexión hermética. Se puede conectar con grifos de 1/2" (cód. 27049) y grifos de 3/4" (cód. 27050).

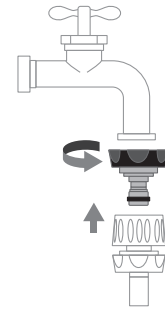

Adaptador rápido latón engomado

Código	Medida	Referencia	
27049	1/2"	ARL-1/2	12
27050	3/4"	ARL-3/4	12

Adaptador rápido para conectar la manguera al grifo o a algún accesorio de riego. Fácil y sin herramientas. Apto para mangueras de Ø13 interior (1/2"), cod. 27049, y mangueras de Ø19 interior (3/4"), cód. 27050.

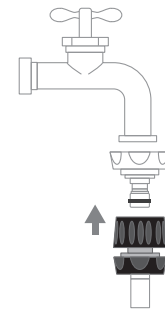

Reparador de manguera latón

Código	Medida	Referencia	
27051	1/2"	RML-1/2	12
27052	3/4"	RML-3/4	12

El reparador de manguera permite reparar rápida y fácilmente sin herramientas. Cortar la parte dañada de la manguera e inserta el reparador. Apto para mangueras de Ø13 interior, (1/2").

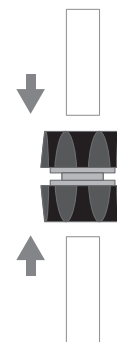

Boquilla latón para manguera

Código	Referencia	
27124	BML	12

Boquilla para manguera con chorro regulable, de nebulizado a concentrado. Adaptable para mangueras de Ø19mm con un conector de 3/4" y para mangueras de Ø13mm con un conector de 1/2".

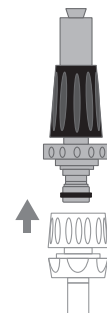



Accesorios de riego de ABS

- La adquisición de estas herramientas de conexión garantizan una mejor organización del sistema de riego.
- Material de buena calidad y duradero.



Adaptador de grifo y reductor de 1/2" a 3/4" y 3/4" a 1"

Código	Medida	Referencia	
24317	1/2" a 3/4"	AGO1	20
24318	1" a 3/4"	AGO2	20

Fácil de conectar, garantiza una conexión hermética. Se puede conectar con grifos de 3/4" con reducción a 1/2" (cód. 24317) y a 1" (cód. 24318).

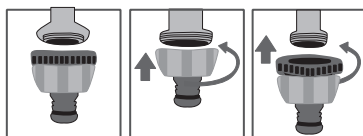

Reparador para manguera de 1/2" y 3/4"

Código	Medida	Referencia	
24319	1/2"	RM01	20
24320	3/4"	RM02	20

El reparador de mangueras permite reparar de forma rápida y fácil sin herramientas. Sencillamente, se corta la parte dañada de la manguera y se inserta el reparador. Apto para mangueras de Ø13, interior 1/2" (cód. 24319) y apto para mangueras de Ø19, interior 3/4" (cód. 24320).

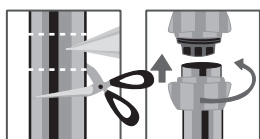

Reparador para manguera de 1/2" y 3/4"

Código	Medida	Referencia	
24314	1/2"	CR-1/2	20
24313	3/4"	CR-3/4	20

El conector rápido se utiliza para conectar la manguera rápidamente al grifo o a algún accesorio de riego. Se conecta fácilmente y sin herramientas. Apto para mangueras de Ø13, interior 1/2" (cód. 24314) y apto para mangueras de Ø19, interior 3/4" (cód. 24313).

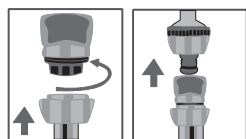

Conector rápido estándar para grifos de 1/2" y 3/4"

Código	Medida	Referencia	
24316	1/2"	CRS-1/2	20
24315	3/4"	CRS-3/4	20

El conector rápido y con AQUA STOP se utiliza para cortar el caudal sin tener que ir al grifo. Se conecta fácilmente y sin herramientas. Apto para mangueras de Ø19 interior (3/4"), cód. 24315, y mangueras Ø13 (1/2"), cód. 24316.

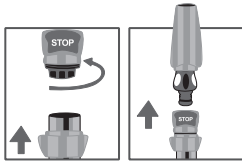

Conector simple para mangueras

Código	Acabado	Referencia	
24689	Negro	CJ2	20

Fácil de conectar, garantiza una conexión hermética. Para unir fácilmente dos mangueras usando dos conectores de manguera. Apto para conectores de 1/2" y 3/4" (CR-1/2, CR-3/4).

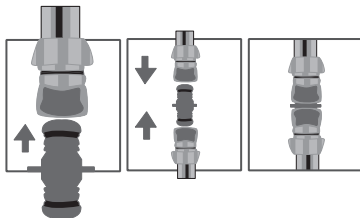

Conector triple para mangueras

Código	Acabado	Referencia	
24688	Naranja/negro	CJ3	20

Fácil de conectar, garantiza una conexión hermética para unir fácilmente dos mangueras, usando tres conectores de manguera. Apto para conectores de 1/2" y 3/4" (CR-1/2, CR-3/4).

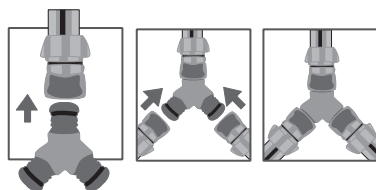

Boquilla de riego ajustable para manguera

Código	Acabado	Referencia	
24321	Naranja/negro	BRA01	20

La boquilla de riego ajustable es ideal en combinación con mangueras más largas o para utilizar con bombas. El chorro puede ajustarse de nebulizado a concentrado. Apto para mangueras de Ø19mm con un conector (3/4"). Y para mangueras de Ø13mm con un conector (1/2").

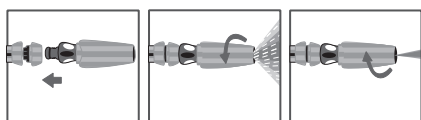

Kit de riego con boquilla, conector 1/2" 'aqua stop', conector 1/2" y adaptador reductor de 1/2" a 3/4"

Código	Acabado	Referencia	
24330	Naranja/negro	KR01	12

Kit 4 piezas: Boquilla de riego ajustable de nebulizado a concentrado. Apto para mangueras de Ø19mm con el reductor de 3/4" a 1/2". Apto para mangueras de Ø13mm con conector de 1/2" y con conector 1/2" con AQUA STOP.

CONECTOR 1/2"
AQUA STOP



**4
PZAS**

CONECTOR 1/2"



BOQUILLA AJUSTABLE



ADAPTADOR GRIFO
REDUCTOR DE 1/2" A 3/4"



Adaptador grifo riego 2 vías

Código	Acabado	Referencia	
27292	Naranja/negro	HPJ24	12

Distribuidor de 2 vías, se conecta directamente a 2 dispositivos, para grifos de 3/4" y 1/2".



2 vías independientes con regulación de flujo

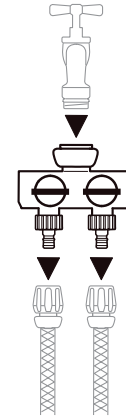

Adaptador grifo riego 4 vías

Código	Acabado	Referencia	
27293	Naranja/negro	HPJ25	12

Distribuidor de 4 vías, se conecta directamente a 2 dispositivos, para grifos de 3/4" y 1/2".



4 vías independientes con regulación de flujo

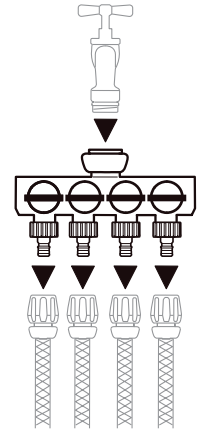

Pistola metálica multifunción (7 posiciones) para mangueras

Código	Acabado	Referencia	
24323	Naranja/negro	PMM02	12

Pistola con 7 chorros diferentes: 1. Chorro, 2. Nebulizado, 3. Centro, 4. Cono, 5. Presión, 6. Ducha, 7. Plano. Caudal ajustable y empuñadura ergonómica.

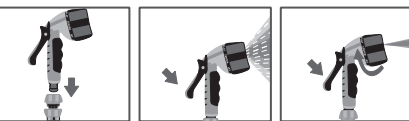

7
Posiciones

Chorro
Cono
Centrado
Plano
Plano
Ducha
Presión
Nebulizado



Pistolas de riego

- Las pistolas rociadoras tienen 7 configuraciones de riego que se pueden cambiar, según las necesidades de cada momento, mientras que la pistola con regulador cuenta con patrón de pulverización ajustable gradualmente desde chorro concentrado hasta chorro de cono.
- Empuñadura antideslizante, cómoda de sostener y fácil de usar.

Pistola metálica con regulador para manguera

Código	Acabado	Referencia	
27291	Verde/negro	HPJ23	10

Pistola con 7 chorros diferentes: 1. Chorro, 2. Nebulizado, 3. Centro, 4. Cono, 5. Máximo, 6. Ducha, 7. Plano. Caudal ajustable y empuñadura ergonómica.



7
Posiciones

Chorro
Cono
Centrado
Plano
Ducha
Presión
Nebulizado



Pistola metálica con regulador para manguera

Código	Acabado	Referencia	
24322	Naranja/negro	PMM01	12

Pistola con chorro regulable de concentrado a nebulizado. Con caudal ajustable y empuñadura ergonómica.

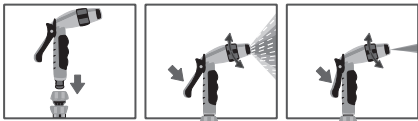

Accesorios de riego automático

- Ahorro de recursos hídricos y energéticos. Proporciona una mayor productividad.
- Cobertura total. A la hora de elegir un sistema u otro, es importante que valores las dimensiones del terreno.

Aspersor de jardín 8 posiciones. 360°

Código	Acabado	Referencia	
27294	Verde/negro	HPJ26	6

8
posic.

8 modalidades de riego

360°

Cobertura total

40-60
PSI

Presión de trabajo

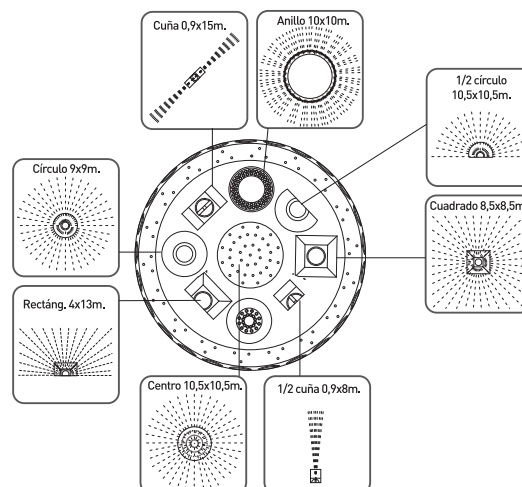

Aspersor metálico sectorial o completo con pincho

Código	Acabado	Referencia	
24333	Gris/dorado	AM-A	12

Ciclo completo o parcial

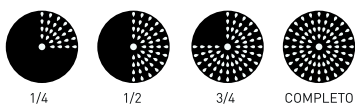

Aspersor plástico sectorial o completo con pincho

Código	Acabado	Referencia	
24332	Verde/amarillo	AP	12

Ciclo completo o parcial

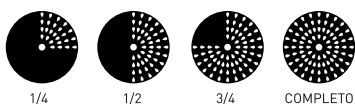

Aspersor metálico sectorial o completo

Código	Acabado	Referencia	
27295	--	HPJ27	12

Ciclo completo o parcial

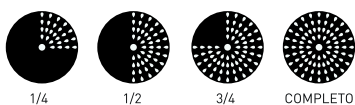

Pincho pasante para aspersor de impulso

Código	Acabado	Referencia	
27296	ZIN	HPJ28	50

Grifo para jardín

Código	Medida	Referencia	
26445	180g.	GRL1/2	12
26446	230g.	GRL3/4	12



Pulverizadores y fumigación

Pulverizador mochila con batería

Código	Capacidad	Referencia	
27637	16L	PF4/16I-BAT	1



Sistema mochila con forma ergonómica para mayor comodidad



Aspersión regulable



Batería de litio 12V/8Ah autonomía aprox. 6-8 horas



Incluye cargador

Medidas: 39x24x59.5cm.
 Peso: 6.0kg.
 Capacidad: 16L.
 Presión de trabajo: 0.20-0.40Mpa.
 Flujo de trabajo: 3.6L/Min.

Batería litio 12v 8Ah para pulverizador PF4/16I

Código	Medida	Referencia	
27642	12v 8Ah	BAT-LIT/16L	1

16L

Capacidad

Pulverizadores automáticos



Pulverizadores manuales

Pulverizador mochila manual, presión previa, blanco

Código	Capacidad	Referencia	
25161	16L	PF4/16l	1

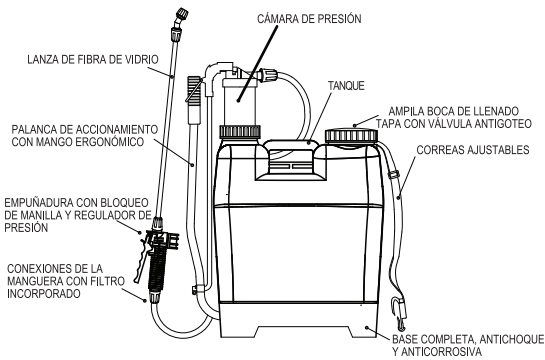

16L
Capacidad



Pulverizador manual, presión previa, blanco

Código	Capacidad	Referencia	
25159	5L	PF3/5l	1

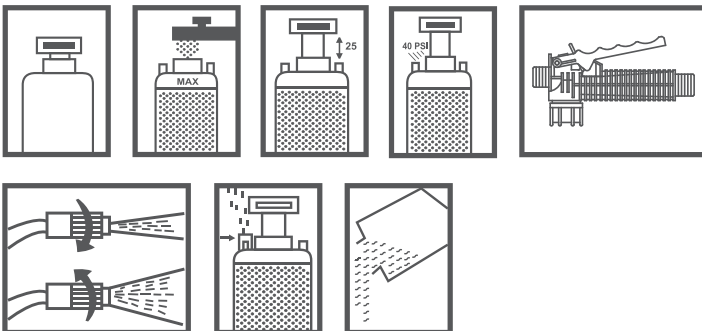

5L
Capacidad



Maneta para lanza pulverizador

Código	Medida	Referencia	
25198	n/d	MAN-PUL	1



Lanzas para pulverizadores

Código	Medida	Referencia	
25160	40cm	LANZ40	4
25162	60cm	LANZ60	4
25163	60-100cm	LANZ-TEL	4



Pulverizador manual, blanco

Código	Capacidad	Referencia	
24682	1L	PF1	1



Pulverizador manual, presión previa, blanco

Código	Capacidad	Referencia	
25158	2L	PF2/2l	1





Herramienta de poda y jardín

Corte y poda

Tijera poda una mano hoja recta muelle espiral

Código	Medida	Referencia	
23727	185mm	HPJ12	10



Tijera corte una mano



Corte recto



Tijera corte una mano



Corte curvo

Tijera poda una mano hoja curva muelle espiral

Código	Medida	Referencia	
23728	185mm	HPJ13	10



Tijera corte una mano



Corte curvo

Tijeras de poda. Hoja acero carbón

Código	Medida	Referencia	
27290	7-1/4"	HPJ22	1

Navaja de poda vendimia, mango nylon, hoja acero inox.

Código	Medida	Referencia	
23729	175mm	HPJ14	10



Navaja de poda injerto, mango madera, hoja acero inox.

Código	Medida	Referencia	
23730	170mm	HPJ15	20



Podaderas y cortasetos

- Se caracterizan por su alta calidad, peso ligero, nitidez, durabilidad, robustez y comodidad.
- Los mangos están diseñados ergonómicamente para protección de impactos, aumentar la fricción para asegurar un agarre firme durante el trabajo y garantizar la seguridad.

Podadera hoja curva bypass, mango aluminio telescópico

Código	Medida	Referencia	
23716	680-1010mm	HPJ01	12



Podadera hoja curva, mango acero oval

Código	Medida	Referencia	
23719	300mm	HPJ04	12
23720	400mm	HPJ05	12
23721	500mm	HPJ06	12



Podadera hoja curva curva yunque, mango aluminio telescópico

Código	Medida	Referencia	
23717	680-1010mm	HPJ02	12



Podadera hoja curva, mango acero con cuchilla

Código	Medida	Referencia	
23722	780mm	HPJ07	12



Podadera ligera hoja curva, mango oval bimaterial nylon, fibra de vidrio

Código	Medida	Referencia	
23723	460mm	HPJ08	12



Cortasetos de hoja ondulada, mango aluminio telescópico

Código	Medida	Referencia	
23718	660-860mm	HPJ03	12



Cortasetos ligero hoja curva, mango oval bimaterial nylon, fibra de vidrio

Código	Medida	Referencia	
23724	600mm	HPJ09	12



Podadera de pértiga sin mango con hoja de corte

Código	Medida	Referencia	
23733	300m	HPJ18	12

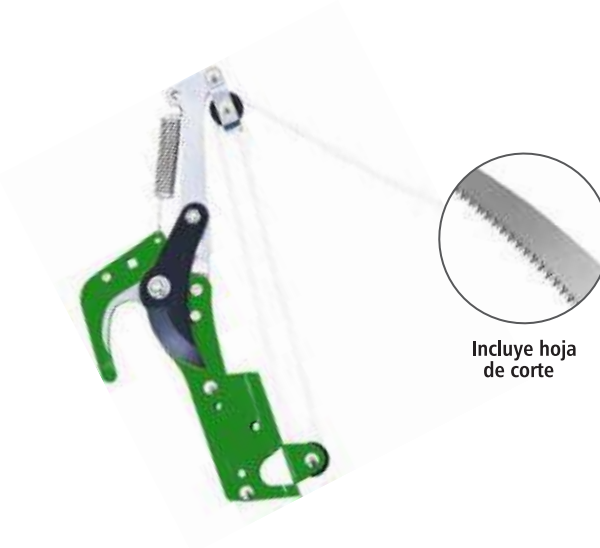

Incluye hoja de corte

Serruchos podadores

- Ligeros y rígidos, asegura una excelente relación entre resistencia mecánica y peso.
- El diseño de los dientes permite el corte por tracción reduciendo el esfuerzo y evitando la torsión de la hoja.

Serrucho podador mango bimaterial

Código	Medida	Referencia	
23732	350mm	HPJ17	12



Serrucho podador para pértiga

Código	Medida	Referencia	
23731	350mm	HPJ16	6



Serrucho podador mango bimaterial

Código	Medida	Referencia	
24685	160mm	SPP01	12



Mangos telescópicos

- Fácil de montar, ideales para serruchos o podaderas, entre otros artículos de poda.
- Instalación por presión.

Mango telescópico de acero extensible

Código	Medida	Referencia	
23735	2,4m	HPJ20	20



Mango telescópico de aluminio extensible

Código	Medida	Referencia	
23734	2,4m	HPJ19	20



Herramienta de jardín

Rastrillo jardín peque. 5 dientes

Código	Medida	Referencia	
27300	----	HPJ32	10



Mango bimaterial

Paleta ancha jardín

Código	Medida	Referencia	
27301	----	HPJ33	10



Mango bimaterial

Azada doble jardín

Código	Medida	Referencia	
27302	----	HPJ34	10



Mango bimaterial

Cortador de maleza. No incluye mango

Código	Medida	Referencia	
27304	----	HPJ36	40



Desmaleza y afloja la tierra

Recogehojas

- Especialmente diseñadas para barrer jardines o parcelas de terreno de forma fácil y rápida. Recoge de forma eficaz hojas y otros residuos sin provocar daños.
- Dientes planos, en metal o polipropileno.
- No incluyen mango.

Escoba metálica jardín 22 dientes

Código	Medida	Referencia	
23736	400mm	HPJ21	50



Herramienta para limpieza

Escoba PP jardín 420mm

Código	Medida	Referencia	
27265	420x400mm	ERH-01	40



Escoba PP jardín 600mm

Código	Medida	Referencia	
27267	600x550mm	ERH-03	30



Escoba PP jardín 520mm

Código	Medida	Referencia	
27266	520x300mm	ERH-02	40



Pinza extensible

- Cuerpo, de aluminio, es ultraligero y proporciona facilidad para recoger y agarrar.
- Presenta pinza con ventosa.



Pinza extensible coge objetos

Código	Medida	Referencia	
27303	----	HPJ35	12

Mallas de protección y delimitación

Malla de plástico con perfil reforzado

QUADRA 05

Código	Acabado	Referencia	
96267	Blanca	QUADRA	1x50m
96268	Verde	QUADRA	1x50m
96446	Blanca	QUADRA	1x5m
96445	Verde	QUADRA	1x5m



QUADRA 10

Código	Acabado	Referencia	
96269	Blanca	QUADRA	1x50m
96270	Verde	QUADRA	1x50m
96444	Blanca	QUADRA	1x5m
96443	Verde	QUADRA	1x5m



QUADRA 20

Código	Acabado	Referencia	
96272	Verde	QUADRA	1x50m
97025	Blanca	QUADRA	1x5m
96447	Verde	QUADRA	1x5m



QUADRATA 05

Código	Acabado	Referencia	
96273	Blanca	QUADRATA	1x25m
96274	Verde	QUADRATA	1x25m



QUADRATA 10

Código	Acabado	Referencia	
96275	Blanca	QUADRATA	1x25m
96276	Verde	QUADRATA	1x25m



QUADRATA 20

Código	Acabado	Referencia	
96277	Blanca	QUADRATA	1x25m
96278	Verde	QUADRATA	1x25m

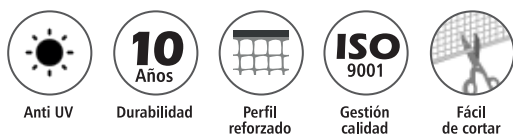

Mallas de plástico

- Solución sencilla, versátil y decorativa, ideal para múltiples aplicaciones, según el tipo de malla y el color. Manejables, fáciles de cortar e instalar. Están fabricadas con polímeros completamente reciclables, atóxicos y de primera calidad.

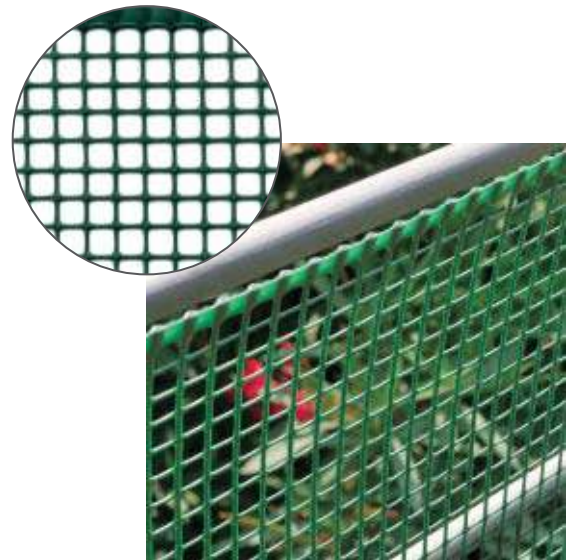



Accesorios maquinaria jardinería

Accesorios desbrozadora

Hilo desbrozadora

- Hilo de alta calidad, fabricado con polímeros, que aportan la máxima resistencia al desgaste.
- Opción de modelo DUAL con mayor resistencia y más rapidez de corte.

Hilo nylon para desbrozadora

Código	Medida	Referencia	
27797	15m-Ø1.6mm	HND-N	10
21196	15m-Ø2.0mm	HND-N	10
21197	15m-Ø2.4mm	HND-N	10
21198	15m-Ø2.7mm	HND-N	10
21199	15m-Ø3.0mm	HND-N	10
21200	65m-Ø2.4mm	HND-N	10
21201	65m-Ø3.0mm	HND-N	10
27798	160m-Ø3.0mm	HND-N	6



Hilo nylon



Hilo nylon para desbrozadora DUAL. Alta resistencia

Código	Medida	Referencia	
21202	60m-Ø2.4mm	HND-DUAL	10
21203	60m-Ø3.0mm	HND-DUAL	10
21204	168m-Ø3.0mm	HND-DUAL	6



Hilo nylon
DUAL



 ALTA RESISTENCIA

 RAPIDEZ DE CORTE

Cabezal auto. desbrozadora aluminio

Código	Medida	Referencia	
27245	8x1,25mm	CDA-4ADP	10

Adaptable a todas las desbrozadoras de tubo recto:

Incluye roscas HEMBRA 10x125+10x100+12x175 MACHO 8x125. Estas distintas roscas permiten adaptar el cabezal en el 95% de las desbrozadoras del mercado de todas las marcas existentes. Solo hace falta cambiar la rosca interior, desmontando el cabezal y presionando la rosca para introducir la nueva en su encaje.

Carga rápida: Sistema de carga fácil sin necesidad de desmontar el cabezal.

Reforzado: Fabricado con plástico resistente y con tapón de aluminio para minimizar el desgaste.

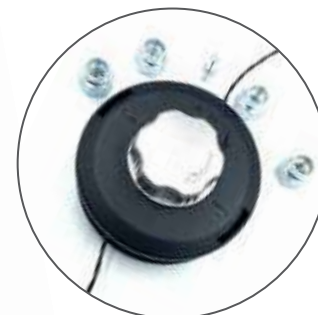

Cuchillas y discos desbrozadora

- Muy útiles para desbrozar y eliminar la maleza, así como matorrales y pequeños arbustos.
- Duraderos y de alto rendimiento.

Cuchilla trituradora para desbrozadora 270mm

Código	Medida	Referencia	
27257	270x2Tx20x4.0	CTD-270	5

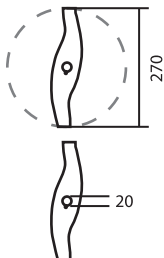

Cuchilla trituradora para desbrozadora 310mm

Código	Medida	Referencia	
27252	310x2Tx25.4x3.0	CTD-310	5

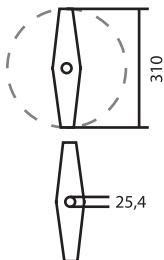

Cuchilla 3 dientes para desbrozadora 300mm

Código	Medida	Referencia	
27250	300x3Tx20x3.0	CUD3-300	5
27251	300x3Tx25.4x3.0	CUD3-300	5



Disco widia desbrozadora 20 DIENTES

Código	Medida	Referencia	
27249	255x20Tx25.4x1.8	DWD-255	5

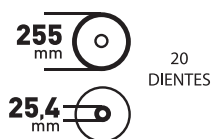

Accesorios motosierra



Cadena para motosierra

- Cadenas ligeras, uniformes, idóneas para la poda. Realiza hasta los trabajos más pequeños con la máxima precisión.
- Duraderas, de fácil mantenimiento y resistentes.

Cadena motosierra 3/8"

Código						
27600	3/8"	1,3mm 0.05"	50	0.65mm 0.025"	< 35cm - 14"	4mm 5/32"
27601	3/8"	1,3mm 0.05"	55	0.65mm 0.025"	< 40cm - 16"	4mm 5/32"

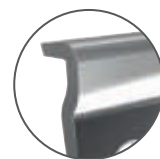

Cadena motosierra 3/8" en rollo

Código					Metros
27602	3/8"	1,3mm 0.05"	0.65mm 0.025"	4mm 5/32"	30,4
27603	3/8"	1,3mm 0.05"	0.65mm 0.025"	4mm 5/32"	30,4
27604	3/8"	1,5mm 0.058"	0.65mm 0.025"	4mm 5/32"	30,4



Conector cadena motosierra

Código	Medida	Referencia	
27605	3/8"	CO-CMOT3/8"	100
27606	3/8"	CO-CMOT325"	100



Limas cadena motosierra

- Accesorio especialmente desarrollado para afilar la motosierra con total seguridad.
- Realizadas en materiales de alta calidad para aumentar la durabilidad.

Lima cadena motosierra

Código	Medida	Referencia	
27607	4mm	LI-CMOT-4mm	12
27608	4,5mm	LI-CMOT-4,5mm	12
27609	4,8mm	LI-CMOT-4,8mm	12



Mango bimaterial para lima cadena motosierra

Código	Medida	Referencia	
27610	Ø3mm	LI-CMOT/M3mm	10



Protección y seguridad

Pantallas de protección

- Protectora transparente de gran calidad. Protege los ojos y la piel de la cara de la proyección de partículas, del polvo de partículas gruesas o de salpicaduras de líquidos a presión.
- Ideal para trabajar con motosierras y desbrozadoras.
- Disponible con pantalla protectora facial de policarbonato y de nylon.

Pantalla protectora facial policarbonato

Código	Visera	Referencia	
27253	Amarilla	PF-POL	20



Norma europea

Pantalla protectora facial nylon

Código	Visera	Referencia	
27254	Amarilla	PF-MALL	20



Norma europea



Toldos de exterior

Toldos de polietileno

Toldo azul, doble lámina, polietileno, ojal de aluminio cada 1 metro

Código	Medida	Gramos/m ²	Referencia	
22790	2x3m	100	NKT4403	40
26361	3x4m	100	NKT4403	40
22791	4x5m	100	NKT4403	10
26362	4x6m	100	NKT4403	10
22792	5x8m	100	NKT4403	5
22793	6x10m	100	NKT4403	4
22794	8x12m	100	NKT4403	2
22795	10x15m	100	NKT4403	1

Toldo azul y plata, doble lámina, polietileno, ojal de aluminio cada 0,50 metros

Código	Medida	Gramos/m ²	Referencia	
22796	2x3m	190	NK7910	40
22797	4x5m	190	NK7910	6
22798	5x8m	190	NK7910	3
22799	6x10m	190	NK7910	2
22800	8x12m	190	NK7910	1

Toldos

- Indicado, sobre todo, para recubrir piscinas y residuos.
- Resistente y fácil de instalar, ya que el producto incluye los ojales para su fijación.
- Protege de la lluvia y las inclemencias del tiempo.



ACCESORIOS Y QUÍMICOS PARA PISCINA

Ferrotech tiene, con su marca Liquid Pool, todo lo necesario para el mantenimiento y el cuidado de piscinas. Desde bombas y equipos monobloc hasta robots limpiafondos, accesorios de limpieza manual o químicos de piscina y complementos para el análisis del agua.

09



Bombas y filtración **192**

Filtros laminados y compactos 192

Electrobombas 193

Limpieza de superficie y fondo **193**

Limpiafondos eléctrico 193

Recogehojas y cepillo manual 194

Limpiafondos manual 196

Químicos para piscina **198**

Cloros multiefectos y rápidos 198

Tratamiento del agua y limpiadores 202

Pintura para piscinas 207

Complementos para el tratamiento del agua 207



Bombas y filtración

Filtros laminados y compactos



Filtro laminado 500L

Referencia	Medida	
20611FT200	Ø500mm	1

- Conexiones 1 1/2".
- Caudal m³/h (a 50m³/h/m²)=9.
- Piscina (volumen) m³ (8 h)*=72.
- Carga de arena (kg)=90.
- Presión máx de trabajo (kg/cm²)=2,5.
- Peso neto (kg)=18.

* 8 horas de periodo de renovación.

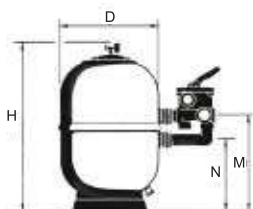

Medidas (mm)
DØ=500 / H=770 / M=415 / N=290.



Válvula selectora para filtrar, lavar, enjuagar, recircular, vaciar y cerrar el filtro

Filtro compacto monobloc

- Conjunto de filtración completo incluye bomba, filtro, válvula selectora, manómetro.
- Muy compacto, fácil de instalar y de utilizar.

Filtro compacto monobloc

Código	Medida	Referencia	
27239	530x485mm	MFLA-250	1

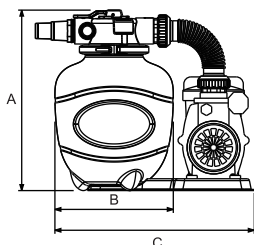

Medidas (mm)
A=380 / B=250 / C=430.

- Conexiones 1 1/2".
- Caudal m³/h (a 50m³/h/m²)= X.
- Piscina (volumen) m³ (8 h)*= X.
- Carga de arena (kg)=8.
- Presión máx de trabajo (kg/cm²)=X.
- Peso neto (kg)=X.



Válvula selectora para filtrar, lavar, enjuagar, recircular, vaciar y cerrar el flujo



Electrobomba piscina 3/4CV

Código	Medida	Referencia	
73678	10.500l/m	Verdom	1

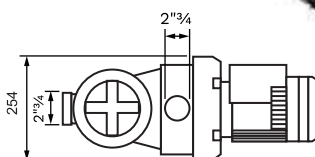
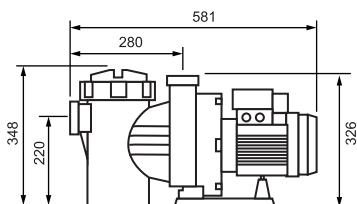

Electrobomba

- Potencia P2 (CV)= 3/4.
- Voltaje= 230.
- H Max. (m.H2O)= 14.
- Caudal (m3/H)= 10,5.
- Nivel ruido (DBA)= 64.
- Conectotes= D.50.
- Peso= 13Kg.

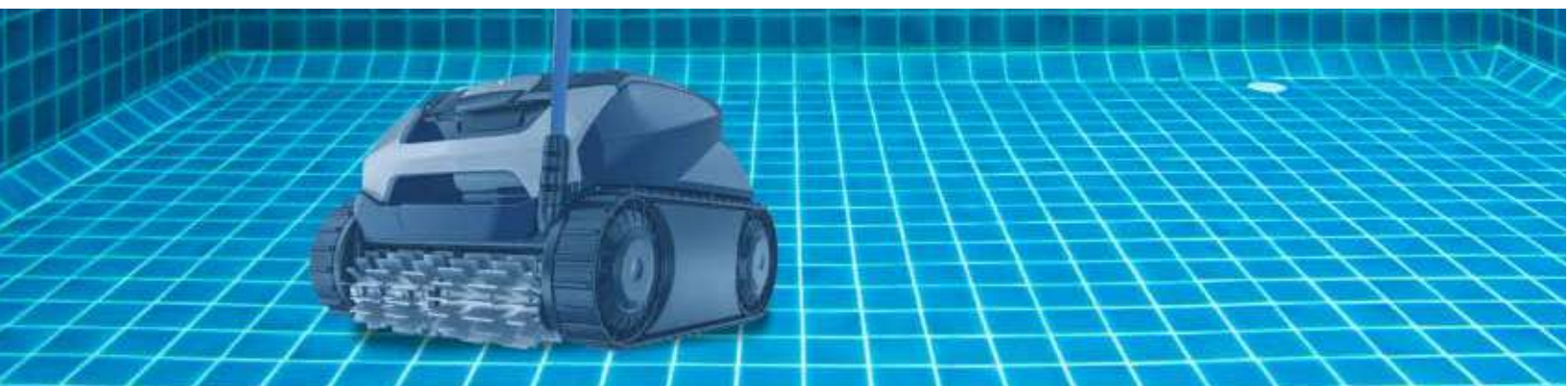

Limpieza de superficie y fondo

Limpiafondos eléctrico

Limpiador eléctrico

Referencia	Medida	
RE-4200	430x400x300mm	1

- Nº motores: 3.
- Modos limpieza: 2.
- Superficie del filtro: 1066cm².
- Capacidad del filtro: 4L.
- Cobertura de limpieza: 23cm.
- Longitud del cable: 15m.
- Sistema de tracción: Orugas.
- Transmisión: Engranajes.
- Seguridad: Sistema playa, parada automática fuera del agua, protección electrónica de los motores.



TAPA TRANSPARENTE
Permite visualizar los residuos recogidos en el filtro



ACCESO SUPERIOR AL FILTRO
Facilita el uso diario

Robot limpiafondos

- Limpia fondo, paredes y línea de flotación de forma autónoma.
- Utiliza su propio sistema de filtración para retener la suciedad de la piscina.



ASPIRACIÓN CICLÓNICA



FÁCIL MANIPULACIÓN

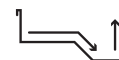

PARA PISCINAS RÍGIDAS CON CUALQUIER FORMA

Recogehojas y cepillo manual



Recogehojas

- Mallas finas y resistentes.
- Estructura de alta calidad.
- Para limpieza de fondo y superficie.

Recogehojas de superficie PVC

Código	Medida	Referencia	
20528	570x420mm	LQP-004-P	6



Fijación rápida universal

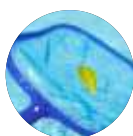

Para limpieza en superficie



Cuello de aluminio



Recogehojas de fondo PVC

Código	Medida	Referencia	
20529	530x485mm	LQP-004-1-P	6

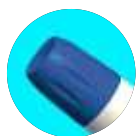

Fijación rápida universal



Para limpieza de fondo

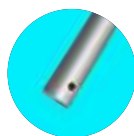

Cuello de aluminio



Recogehojas de superficie PVC

Código	Medida	Referencia	
20459	295x310mm	LQP-004	24



Fijación clip



Para limpieza en superficie



Recogehojas de fondo PVC

Código	Medida	Referencia	
20460	375x170mm	LQP-004-1	24



Fijación clip



Para limpieza de fondo

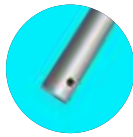

Cuello de aluminio



Recogehojas PVC de superficie con pértiga

Código	Medida	Referencia	
20461	1810x295mm	LQP-004-2	12



Fijación clip

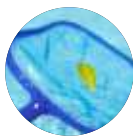

Para limpieza en superficie

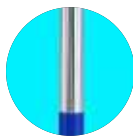

Pértiga de aluminio 1500xØ22mm



Cepillo para piscina

- Cepillo de 45cm, suficiente para áreas grandes.
- Cerdas de nylo resistentes.
- Para limpieza de fondo y paredes.

Cepillo curvo cerdas nylon

Código	Medida	Referencia	
20456	450mm	LQP-002	24



Fijación clip



Para limpieza de paredes y fondo



Cerdas de nylon



Mango telescópico

- Doble opción de fijación: palomilla y clip.
- Fabricado en aluminio de alta calidad y sistema de ajuste en ABS.

Mango aluminio telescópico para accesorios de limpieza

Código	Medida	Referencia	
20462	2x180cm	LQP-005	20



Telescópico

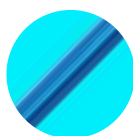

Estrido para mejor agarre



Limpiafondos manual



Limpiafondos

- Modelos en aluminio y ABS.
- Materiales de alta calidad.
- Uso con boquilla aspiración o skimmer.

Limpiafondo con ruedas con conector para manguera de aspiración de Ø38mm

Código	Medida	Referencia	
20457	345x130mm	LQP-003	4



Fijación clip



Ruedas para mejor deslizamiento



Cuerpo de aluminio



Cepillo de arrastre



Limpiafondo con ruedas con conector para manguera de aspiración de Ø38mm

Código	Medida	Referencia	
27235	345x130mm	LQP-003/P	4



Fijación palomilla



Ruedas para mejor deslizamiento



Cuerpo de aluminio



Cepillo de arrastre



Limpiafondo triangular con conector giratorio para manguera de aspiración de Ø38mm

Código	Medida	Referencia	
20458	270mm	LQP-003-1	6



Fijación clip



Especial para piscinas cuadradas



Conector giratorio



Cepillo de arrastre



Limpiafondo con ruedas con conector para manguera de aspiración de Ø38mm

Código	Medida	Referencia	
20527	650x390mm	LQP-003-P	4



Fijación rápida universal



Especial para piscinas cuadradas



Conector giratorio



Cepillo de arrastre



Aspiradora manual medialuna con conector rápido para manguera y bolsa recolectora

Código	Medida	Referencia	
20463	260x160mm	LQP-003-2	12



Fijación clip



Conector rápido para manguera



Bolsa recolectora



Cepillo de arrastre



Al conectar una manguera de jardín, el agua entra en la aspiradora y crea un efecto de succión, arrastrando las hojas y otros desechos a la bolsa de recolección.



Racor manguera flexible

Código	Medida	Referencia	
27470	1 1/2"	RMP38-1 1/2"	24



Manguera autoflotante con manguitos

Referencia	Medida	
TRANSFLOT	8m	4
TRANSFLOT	10m	4
TRANSFLOT	15m	4

- Flotabilidad asegurada durante el servicio de trabajo.
- Fácil manejo en limpiafondos de piscinas manuales y automáticos.
- Resistente a rayos UV, al frío y a la rotura en el alargamiento.
- Radio de curvatura dos veces de su diámetro interior.
- Gran estanqueidad entre las boquillas y el tubo.
- Soporta temperaturas entre -25°C y +55°C.





Químicos para piscina

Cloros multiefectos y rápidos



Cloros multiefectos

- Máxima eficacia desinfectante y de limpieza.
- Tratamientos completos en una sola pastilla.

Cloro 10 efectos, pastilla bicapa 200g

BICAPA

Código	Medida	Referencia	
27125	5Kg	CL10E200GR	4



2x50m³



Tratamiento SEMANAL

- Desinfectante.
- Algicida.
- Floculante.
- Estabilizante.
- Controlador del pH.
- Bactericida.
- Abrillantador.
- Anticalcáreo.
- Bacteriostático.
- Clarificante.

10
EFECTOS



Cloro 10 efectos, pastilla 200g

MONOCAPA

Código	Medida	Referencia	
27939	5Kg	LQP-019	4



2x50m³



Tratamiento SEMANAL

- Desinfectante.
- Algicida.
- Floculante.
- Estabilizante.
- Controlador del pH.
- Bactericida.
- Abrillantador.
- Anticalcáreo.
- Bacteriostático.
- Clarificante.

10
EFECTOS



Cloro 5 efectos, pastilla 200g

Código	Medida	Referencia	
20544	5Kg	LQP-007	4
27475	10Kg	LQP-007/10K	1



2x50m³



Tratamiento SEMANAL

- Desinfectante.
- Algicida.
- Floculante.
- Anticalcáreo.
- Controlador del pH.



Cloro multifunción sin cobre en pastilla

Código	Medida	Referencia	
27476	2Kg	CLMUL-2KG	6
27477	5Kg	CLMUL-5KG	4



20g (2Kg)
200g (5Kg)

2x50m³



Tratamiento SEMANAL

- Desinfectante.
- Algicida.
- Floculante.
- Anticalcáreo.
- Controlador del pH.



Cloro 10 efectos. Alboral 10

Referencia	Medida	
201205	5Kg	4



1x35m³



Tratamiento SEMANAL

- Desinfectante.
- Algicida.
- Floculante.
- Estabilizante.
- Controlador del pH.
- Bactericida.
- Abrillantador.
- Anticalcáreo.
- Bacteriostático.
- Clarificante.



Cloro 5 efectos. Quimidor PS

Referencia	Medida	
201805	5Kg	4

 1x35m³
250g

 **7** Tratamiento SEMANAL

- Desinfectante.
- Algicida.
- Floculante.
- Anticalcáreo.
- Controlador del pH.



Kit mini-piscinas

Referencia	Medida	
202102	500g	12

Tratamiento combinado para piscinas hinchables y portátiles sin depuradora. Incluye: ALBORAL PS RAPID (500g) y CATIGENE PS (500ml).



Cloros rápidos

- Cloro granulado para tratamiento de choque.
- Clorado rápido del agua.

Cloro rápido granulado

Código	Medida	Referencia	
20546	1Kg	LQP-008-1	12
20545	5Kg	LQP-008-5	4

 **Arranque:**
150g x 10m³.
Mantenimiento:
10/30g x 10m³.

 **1** Tratamiento DIARIO



Cloro rápido granulado. Cloro Shock

Código	Medida	
27865	500gr	12



Dosis:
500gr x 25m³



Recuperador
aguas turbias

 **Acción rápida**

Cloro rápido líquido

Código	Medida	
27863	5Kg	4



Arranque: 4L x 50m ³ .
Mantenimiento: 2L x 50m ³ .

 **Tratamiento
DIARIO**



Cloro rápido granulado. Choc Rapid

Referencia	Medida	
202501	500g	12



Dosis:
500g x 25m³.



Antialgas

Código	Medida	Referencia	
20548	5L	LQP-010	4

	Arranque: 1,5l. x 50m ³
	Mantenimiento: 0,75l. x 50m ³

 Tratamiento SEMANAL



Antialgas

- Modelos con diferentes durezas.
- Maza color negro para trabajos donde no se puede emplear cabeza de acero.

SIN COBRE
Especial piscinas
Poliéster
liner y gresite

Algicida extra

Código	Medida	Referencia	
27936	500ml	LQP-016	12

	Arranque: 1,5l. x 50m ³
	Mantenimiento: 0,75l. x 50m ³

 Tratamiento SEMANAL



SIN COBRE
Especial piscinas
Poliéster
liner y gresite

Tratamiento del agua y limpiadores

Clarificante doble efecto

Código	Medida	Referencia	
27126	5L	CLA2x1/5L	4

	Arranque: 3l. x 50m ³
	Mantenimiento: 1,5l. x 50m ³

 Tratamiento SEMANAL



Clarificante

- Para corregir el agua turbia o lechosa.
- Función complementaria antialgas.

 + 
CLARIFICANTE ANTIALGAS

Floculante clarificador

Código	Medida	Referencia	
20547	5L	LQP-009	4

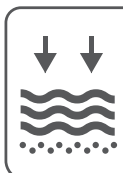

Precipita la materia en suspensión al fondo de la piscina, facilitando su posterior limpieza
No altera el PH*
 *Siempre y cuando se utilice la dosis apropiada de producto



Floculante

- Para aglutinar los sólidos que están en suspensión sobre el agua y que puedan ser filtrados fácilmente.

ESPECIAL
Aguas turbias

Floculante clarificador en cartuchos

Código	Medida	Referencia	
27866	1Kg (8x125g)	LQP-014	1

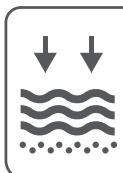

Precipita la materia en suspensión al fondo de la piscina, facilitando su posterior limpieza
No altera el PH*
 *Siempre y cuando se utilice la dosis apropiada de producto

 **8 x 125g**
125g x 50m3



ESPECIAL
Aguas turbias

Floculante clarificador en gel 90g

Código	Medida	Referencia	
27867	90g	LQP-015	1

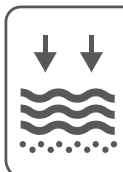

Precipita la materia en suspensión al fondo de la piscina, facilitando su posterior limpieza
No altera el PH*
 *Siempre y cuando se utilice la dosis apropiada de producto

90g x 60m3



AGUA CRISTALINA

Reguladores de PH

- Permite aumentar y estabilizar el pH del agua.
- Adecuado y recomendable para todo tipo de piscinas (cubiertas y al aire libre).

Incrementador de PH

Código	Medida	Referencia	
27473	5L	IPH+5L	4



Apto para dosificar con bombas



Minorador de PH

Código	Medida	Referencia	
27472	5L	RPH-5L	4
27522	10L	RPH-10L	2
27523	20L	RPH-20L	1



Apto para dosificar con bombas



Limpiadores

- Detergente extra para la limpieza del vaso de piscina y los filtros de material plástico.
- Acción desincrustante.

Limpiador extra

Código	Medida	Referencia	
27478	5L	LIMP-EX5L	4



Limpeza de incrustaciones calcáreas severas del vaso de la piscina



Limpiador paredes de piscina

Antiavispas

Código	Medida	Referencia	
27740	500ml	HTV-9903	12

	Trat. de choque: 1l. x 100m ³
	Mantenimiento: 0,5l. x 100m ³

 **15** Tratamiento QUINCENAL



Antiavispas

- Actúa reduciendo la tensión superficial del agua, provocando que las avispas caigan al fondo de la piscina y se eliminen mediante el limpiafondos.



Antiavispas

Invernador sólido temperaturas extremas

Código	Medida	Referencia	
27255	2Kg	HTV-752	6

Con este dosificador se evita la descomposición del agua de la piscina durante las épocas en que ésta no se utiliza. Favorece la limpieza, recuperación y puesta a punto del agua de la piscina a principios de temporada.



Boya flotante autosuficadora

Invernador

- Previene la putrefacción del agua, la proliferación de algas y mantiene el agua cristalina. Incluye acción desinfectante, alguicida y floculante.

Invernador líquido temperaturas extremas

Código	Medida	Referencia	
27256	5L	HTV-651	4

Mantenimiento del agua en piscinas descubiertas durante el periodo invernal, evitando la proliferación intensa de algas y bacterias, que producen la putrefacción del agua y la formación de sedimentos calcáreos.



	Dosis recomendada:
	4l. x 50m ³



SIN COBRE
Especial piscinas
Poliéster
liner y gresite

Análisis del agua

- Apto para cualquier tipo de agua, ya sea de piscinas, spas, aguas termales, etc.

Kit test de análisis de PH y cloro

Código	Medida	Referencia	
20464	15 C.C.	LQP-006	72

TEST KIT de análisis para controlar en todo momento la calidad del agua de la piscina. Contenido: Reactivo para la determinación del pH (Rojo Fenol) - Reactivo para la detección del cloro residual (Otolidina) - Recipientes para efectuar los ensayos.



Botes de repuesto para análisis de PH y cloro

Código	Medida	Referencia	
20465	15 C.C.	LQP-006-R	144

Temperatura del agua

- Termómetros flotantes con motivos de animales, para saber la temperatura del agua.

Termómetro flotante para piscina

Código	Medida	Referencia	
27471	--	TPF-ANI	48



Pintura para piscinas

Pintura piscina azul clorocaucho

Código	Medida	Referencia	
27536	4L	PINT-PISC/4L	1



Pintura cloro-caucho

- Pintura impermeable, totalmente resistente al agua y a productos químicos habituales en las piscinas y a la alcalinidad.

Disolvente pintura clorocaucho

Código	Medida	Referencia	
27537	1L	DIS-CLOR	1



Complementos para el tratamiento del agua

Dosificador flotante para tabletas de 200g

Código	Medida	Referencia	
20455	180mm	LQP-001	12



Dosificador de cloro

- Dosificador para suministrar cantidades determinadas de cloro de disolución lenta en pastillas.



CERRAJERÍA

Encuentre todos los artículos necesarios de cerrajería que precise, desde cerraduras de seguridad, de paso y entrada a picaportes unificados, bombillos de serreta, amaestrados, bombillos de seguridad y antibumping, cerraduras de sobreponer, cerrojos de alta seguridad de sobreponer y candados de latón.



Bombillos de latón 216

Bombillos de serreta 216

Bombillos de seguridad 218

Bombillos de seguridad antibumping 219

Cerraduras y picaportes de embutir 209

Cerraduras de embutir madera 209

Picaportes de embutir madera 213

Cerraduras de embutir metal 215

Cerrojos y cerraduras de sobreponer 220

Cerradura de sobreponer 220

Cerrojos de sobreponer 221

Cerrojo alta seguridad 222

Candados 223

Candados de latón 223





Cerraduras y picaportes de embutir

Cerraduras de seguridad

- Cerradura de seguridad monopunto con 4 bulones de acero niquelado de diámetro 14mm.
- Incluye escudo seguridad abierto (Mod. NX100) y escudo de seguridad cerrado (Mod. NX200).
- Disponible en diferentes acabados, con canto cuadrado o redondo.

Cerradura seguridad, escudo abierto



Código	Acabado	Referencia	
23456	Latonado sat.	NX100CC	 Canto cuadrado
23457	Niquelado sat.	NX100CC	
26451	Negro	NX100CC	
26112	Acero inox*	NX100CCAI	
23458	Latonado sat.	NX100CR	 Canto redondo
23459	Niquelado sat.	NX100CR	
26450	Negro	NX100CR	
26113	Acero inox*	NX100CRAI	

*Acero inoxidable 304





Entre ejes
85mm



Escudo seg.
abierto

Cerradura seguridad, escudo abierto con bombillo de seguridad



Código	Acabado	Referencia	
23460	Latonado sat.	NX100CC60	 Canto cuadrado
23461	Niquelado sat.	NX100CC60	
26110	Acero inox*	NX100CC60AI	
23466	Latonado sat.	NX100CR60	 Canto redondo
23467	Niquelado sat.	NX100CR60	
23687	Acero inox*	NX100CR60AI	

* Acero inoxidable 304



Entre ejes
85mm



Escudo seg.
abierto



Bombillo seg.
60mm

Escudo seguridad abierto

Código	Acabado	Referencia	
23489	Latonado sat.	ESA	1
23457	Niquelado sat.	ESA	1

Cerraduras de embutir madera

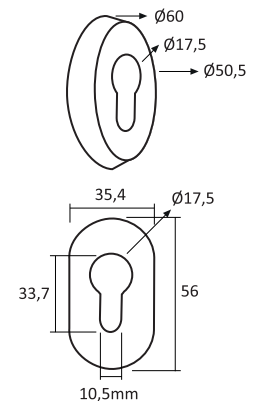
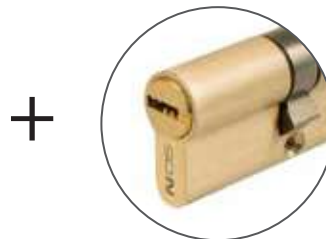
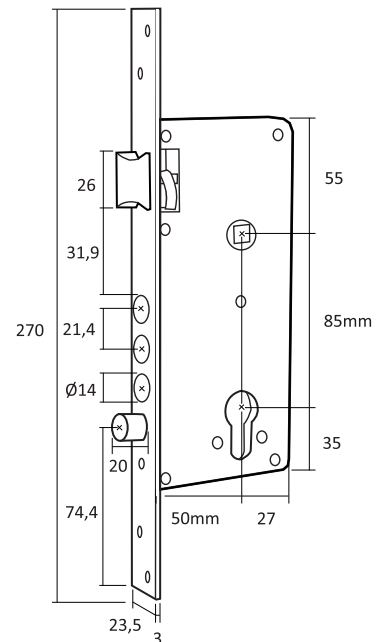
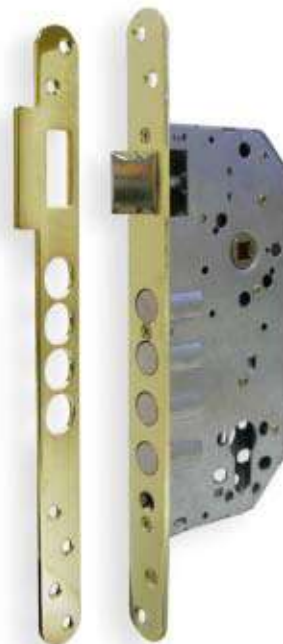

Cerradura seguridad, escudo cerrado



NX200

Código	Acabado	Referencia	
23472	Latonado sat.	NX200CC	 Canto cuadrado
23473	Niquelado sat.	NX200CC	
26108	Acero inox*	NX200CCAI	
23474	Latonado sat.	NX200CR	 Canto redondo
23475	Niquelado sat.	NX200CR	
26109	Acero inox*	NX200CRAI	



Entre ejes 85mm



Escudo seg. cerrado

*Acero inoxidable 304

Cerradura seguridad, escudo cerrado con bombillo de seguridad



NX200

Código	Acabado	Referencia	
23476	Latonado sat.	NX200CC60	 Canto cuadrado
23477	Niquelado sat.	NX200CC60	
26104	Acero inox*	NX200CC60AI	
23482	Latonado sat.	NX200CR60	 Canto redondo
23483	Niquelado sat.	NX200CR60	
23689	Acero inox*	NX200CR60AI	



Entre ejes 85mm



Escudo seg. cerrado



Bombillo seg. 60mm

*Acero inoxidable 304

Escudo seguridad cerrado

Código	Acabado	Referencia	
23491	Latonado sat.	ESC	1
23492	Niquelado sat.	ESC	1

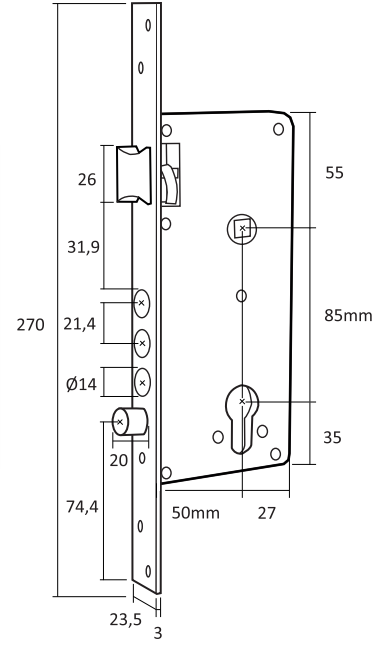

+

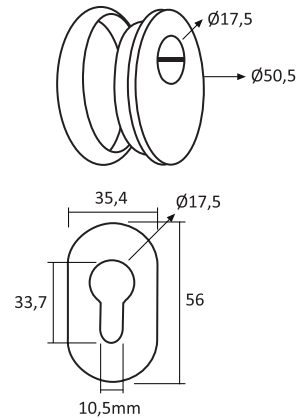





Cerraduras de paso y entrada

- Cerradura con cierre de embutir en puertas de madera interiores, de paso, o de entrada, con canto cuadrado o redondo y diferentes acabados.

Cerradura de paso y entrada E.E. 47mm con bombillo de serreta

1 **N10P**

Código	Medida AxBxC	Acabado	Referencia	
24890	40x47x70	Latonado sat.	N10P/40CC+60	 Canto cuadrado
24891		Niquelado sat.	N10P/40CC+60	
24892		Negro	N10P/40CC+60	
20709		Acero inox*	N10P/40CC+60	
23691	40x47x70	Latonado sat.	N10P/40CR+60	 Canto redondo
23692		Niquelado sat.	N10P/40CR+60	
24893		Negro	N10P/40CR+60	
21002		Acero inox*	N10P/40CR+60	
24894	50x47x80	Latonado sat.	N10P/50CC+60	 Canto cuadrado
24895		Niquelado sat.	N10P/50CC+60	
24896		Negro	N10P/50CC+60	
20712		Acero inox*	N10P/50CC+60	
23693	50x47x80	Latonado sat.	N10P/50CR+60	 Canto redondo
23694		Niquelado sat.	N10P/50CR+60	
24897		Negro	N10P/50CR+60	
20716		Acero inox*	N10P/50CR+60	
23695	60x47x90	Latonado sat.	N10P/60CR+60	 Canto redondo
23696		Niquelado sat.	N10P/60CR+60	



*Acero inoxidable 304

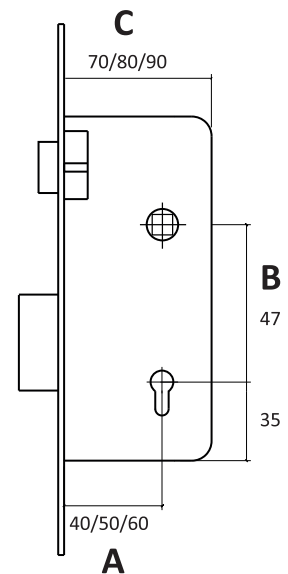



A=Distancia de entrada, del frente al eje del cuadradillo

B=Distancia entre ejes, del bombillo al del cuadradillo

Cerradura de paso y entrada E.E. 85mm con bombillo de serreta



N30

Código	Medida AxbxC	Acabado	Referencia	
24898	40x85x70	Latonado sat.	N30/40CC+60	 Canto cuadrado
24899		Níquel sat.	N30/40CC+60	
24900		Acero inox*	N30/40CC+60	
23708	50x85x80	Latonado sat.	N30/50CR+60	 Canto redondo
23709		Níquelado sat.	N30/50CR+60	
20702		Acero inox*	N30/50CR+60	
24908	60x85x90	Latonado sat.	N30/60CC+60	 Canto redondo
24909		Níquelado sat.	N30/60CR+60	
20705		Acero inox*	N30/60CR+60	



Entre ejes
85mm



Bombillo serreta
60mm

*Acero inoxidable 304

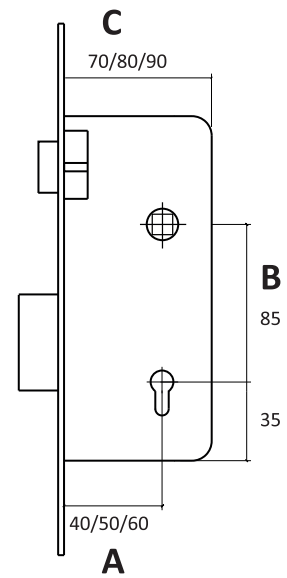

A=Distancia de entrada, del frente al eje del cuadradillo

B=Distancia entre ejes, del bombillo al del cuadradillo

Picaportes de embutir madera

Picaportes unificados

- Picaporte de embutir en madera, con diferentes distancias entre ejes (47 y 70mm), distintos acabados, con canto redondo y también disponibles con cierre silencioso.
- Todos los modelos ofrecen desbloqueo automático.

Picaporte unificado E.E. 47mm



N6134T

Código	Acabado	Referencia
23711	Latonado sat.	N6134T
23712	Niquelado sat.	N6134T
23710	Acero inox*	N6134T
23968	Negro	N6134T
26726	Blanco	N6134T
23741	Bronce inglés	N6134T
27016	Antracita	N6134T



Canto redondo

*Acero inoxidable 304



Entre ejes 47mm



Desbloqueo automático

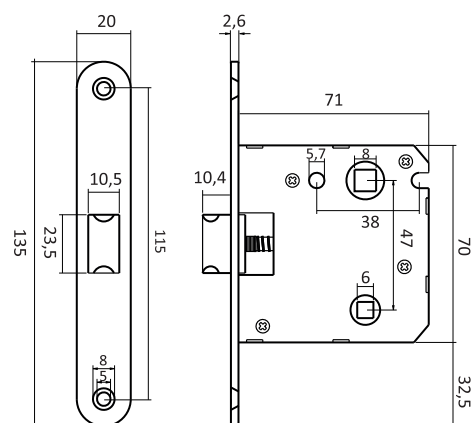

Picaporte unificado E.E. 70mm



N134T

Código	Acabado	Referencia
23714	Latonado sat.	N134T
23715	Niquelado sat.	N134T
23713	Acero inox*	N134T
24006	Negro	N134T
26727	Blanco	N134T
24003	Bronce inglés	N134T
27014	Antracita	N134T



Canto redondo

*Acero inoxidable 304



Entre ejes 70mm



Desbloqueo automático

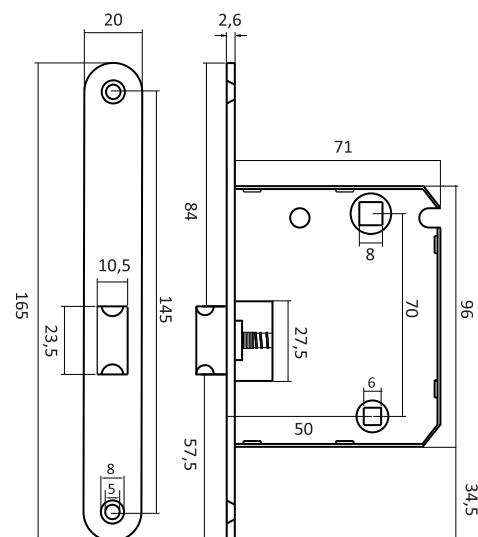

Picaporte unificado E.E. 47mm



N6134T-SIL

Código	Acabado	Referencia
23702	Latonado sat.	N6134T-SIL
23703	Niquelado sat.	N6134T-SIL
23704	Acero inox*	N6134T-SIL



*Acero inoxidable 304



Entre ejes
47mm



Desbloqueo
automático



Cierre
silencioso

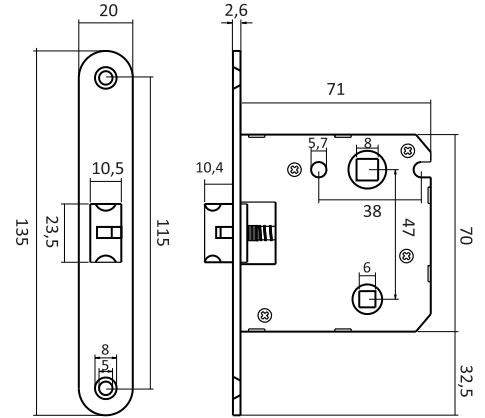

Picaporte unificado E.E. 70mm



N134T-SIL

Código	Acabado	Referencia
23705	Latonado sat.	N134T-SIL
23706	Niquelado sat.	N134T-SIL
23707	Acero inox.	N134T-SIL



*Acero inoxidable 304



Entre ejes
70mm



Desbloqueo
automático



Cierre
silencioso

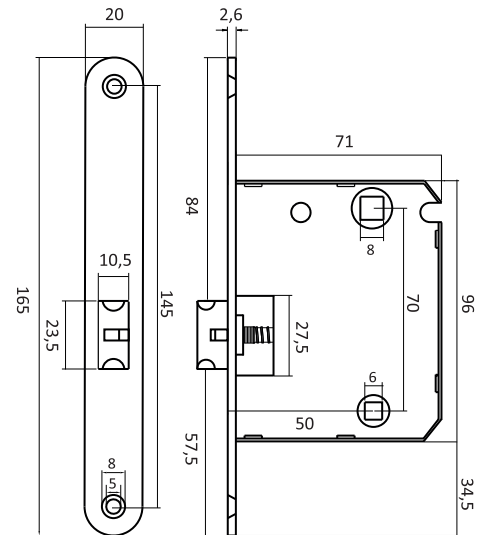

Cerraduras para puerta de metal

- Pensadas para embutir en puerta metálica, disponibles en dos modelos, uno con bulón deslizante sin cerradero (leva 15), y otro con bulón de gancho y cerradero (leva 13), ambos con distancia entre ejes 85mm.

Cerradura de embutir deslizante para puerta metálica sin cerradero. Leva 15

Código	Medida AxBxC	Acabado	Referencia	
24227	33x178x15	Niquelado	N1984/0-20	1
24228	38x178x15	Niquelado	N1984/0-25	1
24229	43x178x15	Niquelado	N1984/0-30	1



Entre ejes
85mm



Leva 13

Cerradura de embutir, de gancho, para puerta metálica con cerradero. Leva 13

Código	Medida AxBxC	Acabado	Referencia	
24230	33x175x25	Niquelado	N190/23/0	1
24231	38x175x25	Niquelado	N190/28/0	1
24232	43x175x25	Niquelado	N190/33/0	1



Entre ejes
85mm



Leva 13

Cerraduras de embutir metal

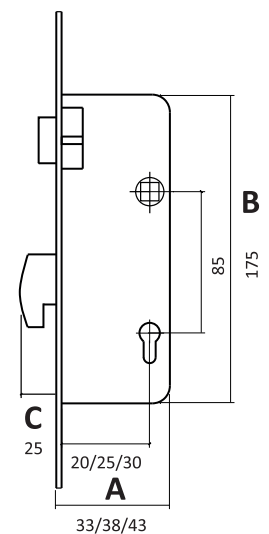
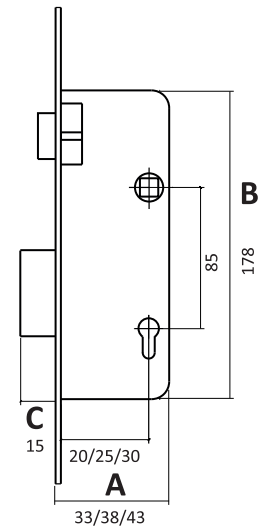









Bombillos de latón

Bombillos de serreta

Bombillos de serreta

- Cilindros para puertas interiores o secundarias, centrados y descentrados, de diferentes acabados y medidas, leva 13 y 15, con tres llaves.
- Ideales para zonas que no requieran de una alta seguridad.

Bombillo de serreta

Código	Bombillo A=B+C	Acabado	Referencia	
23250 23608	40=10+30	Latón sat. Níquel sat.	CN 40DL CN 40DN	
22782 23609	50=10+40	Latón sat. Níquel sat.	CN 50DL CN 50DN	
20843 20844	60=30+30	Latón sat. Níquel sat.	CN 60CL CN 60CN	
21228 22816 21229 21889	70=35+35 70=35+35 70=30+40 70=30+40	Latón sat. Níquel sat. Latón sat. Níquel sat.	CN 70CL CN 70CN CN 70DL CN 70DN	
22783 23054 23052 23053 23055	80=40+40 80=40+40 80=30+50 80=30+50 90=45+45	Latón sat. Níquel sat. Latón sat. Níquel sat. Latón sat.	CN 80CL CN 80CN CN 80DL CN 80DN CN 90CL	
23056 23611 23057 22781 23610	90=45+45 90=30+60 90=30+60 90=40+50 90=40+50	Níquel sat. Latón sat. Níquel sat. Latón sat. Níquel sat.	CN 90CN CN 90DL/60-30 CN 90DN/60-30 CN 90DL/50-40 CN 90DN/50-40	







Leva 15



3 Llaves

Bombillo de serreta, Leva 13

Código	Bombillo A=B+C	Acabado	Referencia	
23246	40=10+30	Níquel sat.	CN 40DN13	
23247	50=10+40	Níquel sat.	CN 50DN13	
21833 23248	60=30+30 60=10+50	Níquel sat. Níquel sat.	CN 60CN13 CN 60DN13	





Leva 13

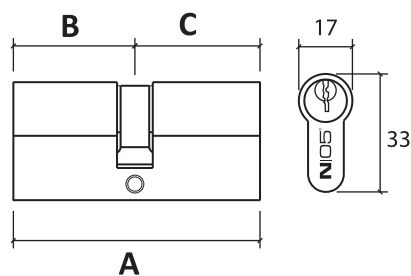

3 Llaves



Código	Bombillo A=B+C	Acabado	Referencia	
22779 22448	70=35+35 70=30+40	Níquel sat. Níquel sat.	CN 70CN13 CN 70DN13	
23241 22780	80=40+40 80=30+50	Níquel sat. Níquel sat.	CN 80CN13 CN 80CN13	

Bombillo de serreta con pomo



Código	Bombillo A=B+C	Acabado	Referencia	
23612	70=35+35P	Latón sat.	CP 70CL	
23613	70=35+35P	Níquel sat.	CP 70CN	



Leva 15



3 Llaves

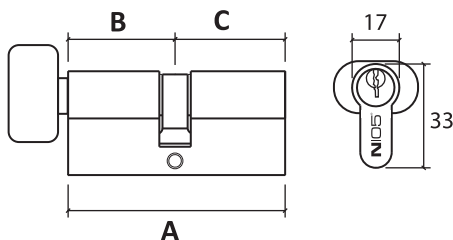

Bombillo de serreta, llaves iguales



Código	Bombillo A=B+C	Acabado	Referencia	Grupo
26382	60=30+30	Níquel sat.	NCN 60CNI-G1	G1
26383	70=35+35	Níquel sat.	NCN 70CNI-G1	
26384	60=30+30	Níquel sat.	NCN 60CNI-G2	G2
26385	70=35+35	Níquel sat.	NCN 70CNI-G2	
26386	60=30+30	Níquel sat.	NCN 60CNI-G3	G3
26387	70=35+35	Níquel sat.	NCN 70CNI-G3	
26388	60=30+30	Níquel sat.	NCN 60CNI-G4	G4
26389	70=35+35	Níquel sat.	NCN 70CNI-G4	
26390	60=30+30	Níquel sat.	NCN 60CNI-G5	G5
26391	70=35+35	Níquel sat.	NCN 70CNI-G5	
26392	60=30+30	Níquel sat.	NCN 60CNI-G6	G6
26393	70=35+35	Níquel sat.	NCN 70CNI-G6	
26394	60=30+30	Níquel sat.	NCN 60CNI-G7	G7
26395	70=35+35	Níquel sat.	NCN 70CNI-G7	
26396	60=30+30	Níquel sat.	NCN 60CNI-G8	G8
26397	70=35+35	Níquel sat.	NCN 70CNI-G8	
26398	60=30+30	Níquel sat.	NCN 60CNI-G9	G9
26399	70=35+35	Níquel sat.	NCN 70CNI-G9	
26400	60=30+30	Níquel sat.	NCN 60CNI-G10	G10
26401	70=35+35	Níquel sat.	NCN 70CNI-G10	



Leva 15

Bombillos de serreta amaestrados

- Útiles en instalaciones que cuentan con varias puertas y, por tanto, con varias cerraduras, ya que su sistema de cierre permite abrir una o varias puertas con una única llave.
- Diferentes acabados, medidas y grupos.

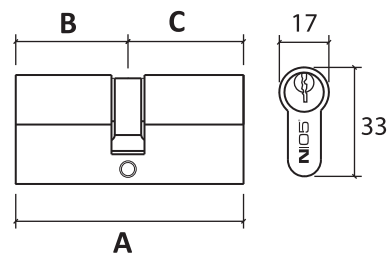
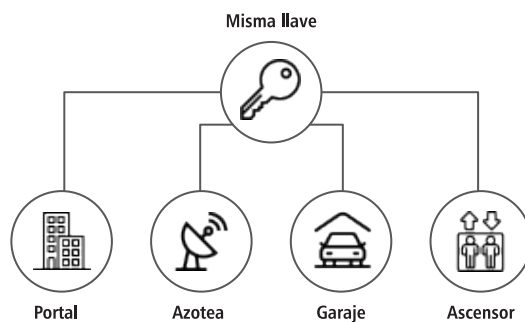

Llave serreta en bruto 5P

Código	Referencia	
24695	NCN LLAV	100



Bombillos de seguridad

Bombillo de seguridad

- Recomendado como medida contra las más rápidas y silenciosas técnicas de robo.
- De seis pines, diferentes acabados y medidas, leva 13 y 15, y cinco llaves.

Bombillo de seguridad 6 pines



Código	Bombillo A=B+C	Acabado	Referencia	
23618	40=30+10	Latón sat.	CS 40DL	
23619	40=30+10	Níquel sat.	CS 40DN	
26195	44,4=10+32,5	Latón sat.	NCS 42,5DL	
26196	44,4=10+32,5	Níquel sat.	NCS 42,5DN	
23620	50=40+10	Latón sat.	CS 50DL	
23621	50=40+10	Níquel sat.	CS 50DN	
26199	60=32,5+32,5	Latón sat.	NCS 65CL	
26200	60=32,5+32,5	Níquel sat.	NCS 65CN	
26201	70=35+35	Latón sat.	NCS 70CL	
26202	70=35+35	Níquel sat.	NCS 70CN	
26203	72,5=32,5+40	Latón sat.	NCS 70DL	
26204	72,5=32,5+40	Níquel sat.	NCS 70DN	
26205	80=40+40	Latón sat.	NCS 80CL	
26206	80=40+40	Níquel sat.	NCS 80CN	
26207	82,5=32,5+50	Latón sat.	NCS 80DL	
26208	82,5=32,5+50	Níquel sat.	NCS 80DN	
26209	90=45+45	Latón sat.	NCS 90CL	
26210	90=45+45	Níquel sat.	NCS 90CN	
26211	92,5=32,5+60	Latón sat.	NCS 90DL/60-30	
26212	92,5=32,5+60	Níquel sat.	NCS 90DN/60-30	
26213	90=40+50	Níquel sat.	NCS 90DN/40-50	
26214	90=40+50	Latón sat.	NCS 90DL/40-50	
26662	100=40+60	Latón sat.	NCS 100 DL	
26663	100=40+60	Níquel sat.	NCS 100 DN	
26681	100=50+50	Latón sat.	NCS 100CN	



Leva 15



6 Pines



5 Llaves seguridad

Bombillo de seguridad 6 pines, Leva 13



Código	Bombillo A=B+C	Acabado	Referencia	
26216	65=32,5+32,5	Níquel sat.	NCS 65CN13	
26217	70=35+35	Níquel sat.	NCS 70CN13	
26218	72,5=32,5+40	Níquel sat.	NCS 72,5DN13	
26219	80=40+40	Níquel sat.	NCS 80CN13	
26220	82,5=32,5+50	Níquel sat.	NCS 82,5DN13	



Leva 13



6 Pines



5 Llaves

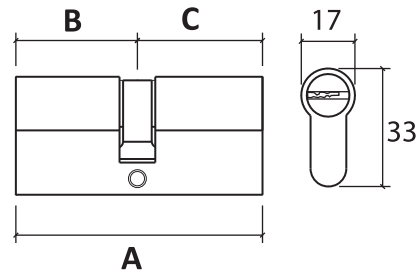

Llave de seguridad en bruto

Código	Referencia	
26215	NCS LLAV	



Bombillo de seguridad antibumping

- Cilindro de seguridad con sistema antibumping.
- Seis pines y distintos elementos que aportan una gran seguridad. Diferentes acabados y medidas. Incluye cinco llaves de seguridad.

Bombillo alta seguridad antibumping

Código	Bombillo A=B+C	Acabado	Referencia	 1
25098	65=32,5+32,5	Latón sat.	CSA 65CL	
25099	65=32,5+32,5	Níquel sat.	CSA 65CN	
25100	70=35+35	Latón sat.	CSA 70CL	
25101	70=35+35	Níquel sat.	CSA 70CN	
25102	72,5=32,5+40	Latón sat.	CSA 70DL	
25103	72,5=32,5+40	Níquel sat.	CSA 70DN	
25106	80=40+40	Latón sat.	CSA 80CL	
25107	80=40+40	Níquel sat.	CSA 80CN	
25104	82,5=32,5+50	Latón sat.	CSA 80DL	
25105	82,5=32,5+50	Níquel sat.	CSA 80DN	



Características:

- Cilindro de Europerfil.
- 5 Llaves.
- Tornillo de Fijación.
- Tarjeta propiedad para duplicado de llaves.

Características técnicas:

- Una sólida barra de acero evita cualquier tentativa de rotura y extracción del cilindro.
- Doble embrague para poder abrir con la llave puesta por dentro.
- Protección frontal antitaladro: 2 barras cementadas en el rotor y 4 en el cuerpo.
- Pitones, arietes y muelles en acero inoxidable.
- Gran variedad de medidas.

Llave en bruto para cilindro Antibumping 6SAB

Código	Referencia	
20356	LL-CSA	100



Bombillos de seguridad antibumping

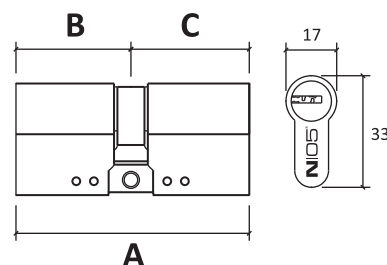

5 Llaves con cabeza de plástico





Cerrojos y cerraduras de sobreponer

Cerradura de sobreponer

Cerradura de sobreponer

- Ideal para instalarse en puertas, portones y rejas de acceso en donde sea imposible usar una cerradura embutida.
- Varias medidas, tres llaves serreta.

Cerradura de sobreponer



3425

Código	Medida AxB	Acabado	Referencia	Mano
24414	80x42	Marrón	3425	Derecha
24415	80x42	Marrón	3425	Izquierda
24416	100x50	Marrón	3425	Derecha
24417	100x50	Marrón	3425	Izquierda
24418	120x60	Marrón	3425	Derecha
24419	120x60	Marrón	3425	Izquierda



3 Llaves serreta



Llave en bruto para cerradura de sobreponer 3425

Código	Referencia	Icono
24420	LL-3425	100



A	B
80mm	42mm
100mm	50mm
120mm	60mm
140mm	70mm

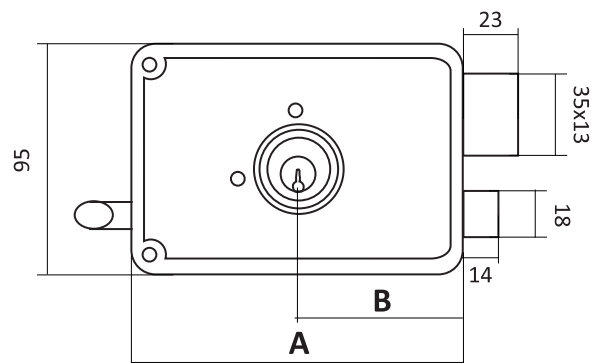

Cerrojo de sobreponer

- Cerrojo de sobreponer estándar con bombillo de serreta.
- Disponible en versión con llave-botón y llave-llave. En acabados gris, cromado y oro.

Cerrojos de sobreponer

Cerrojo con llave - llave

Código	Bombillo	Acabado	Referencia	
20693	50	Gris	N101	
20694	50	Cromado	N101	
20695	50	Oro	N101	
21409	70	Gris	N101-70	
21410	70	Cromado	N101-70	
21411	70	Oro	N101-70	



3 Llaves serreta



Llave-llave



Bombillo de serreta



Cerrojo con llave - botón

Código	Bombillo	Acabado	Referencia	
21193	50	Gris	N101R	
21194	50	Cromado	N101R	
21195	50	Oro	N101R	
21412	70	Gris	N101R-70	
21413	70	Cromado	N101R-70	
21414	70	Oro	N101R-70	



3 Llaves serreta



Llave-Botón

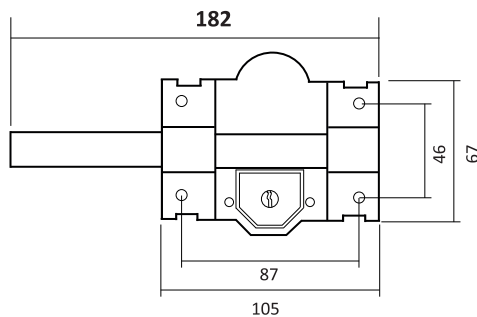

Llave en bruto

Código	Pins	Mod. cerrojo	Referencia	
27310	9	N101	LL-N101/R70	100
27311	11	N101-70	LL-N101-70	100
27319	7	N101R/N101R-70	LL-N101R/R-70	100



Cerrojo alta seguridad

Cerrojo seguridad, cilindro 50mm antibumping/antitaladro
Placa antipalanca, cadena y 5 llaves seg.



Código	Cilindro	Acabado	Referencia
27803	50	Latonado	CERR-SEG/50
27804	50	Cromado	CERR-SEG/50



5 Llaves seguridad



Antibumping



Antitaladro



Cilindro antiganzúa



Placa antipalanca



Cadena de seguridad

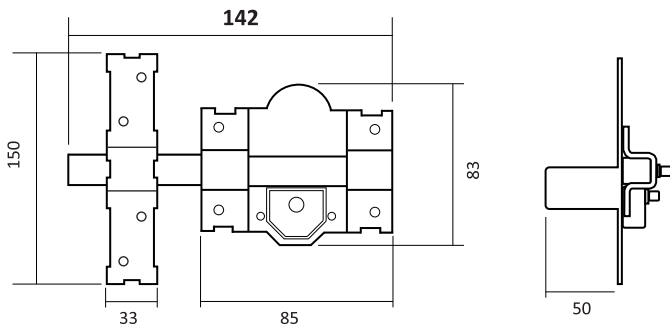

Llave de seguridad en bruto

Código	Referencia	Icono
26215	NCS LLAV	100



Bombillo de seguridad antibumping

Cerrojo alta seguridad sobreponer

- Cerrojo de sobreponer con bombillo de seguridad antibumping y cadena de seguridad.
- Incluye placa de refuerzo para el marco de la puerta.
- Sistema seguro, dificulta la apertura por apalancamiento.

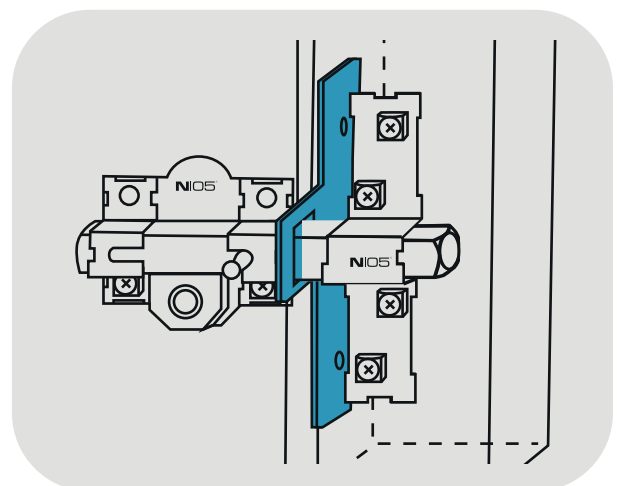
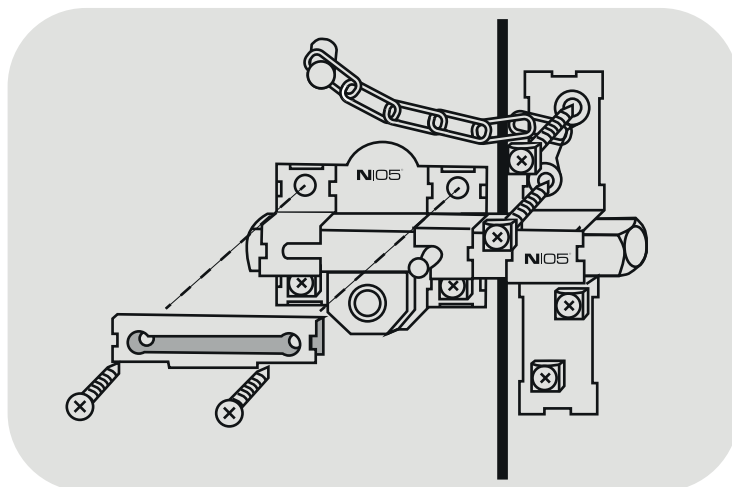

- Puede montarse la cadena suministrada, para añadir un elemento más de seguridad.

- Incluye placa de refuerzo para el marco de la puerta. Esta placa sirve para dificultar la apertura por apalancamiento.



Candados

Candados de latón arco corto y arco largo

- Ofrece protección portátil en sitios donde no se puede instalar una cerradura fija convencional.
- Cuerpo de latón macizo, arco corto y arco largo de acero templado, doble sistema de cierre, protector antihumedad, diferentes grupos y medidas.

Candado clásico, latón, arco corto. 2 llaves

Código	Medida	Referencia	
24527	15	CLAN	12
24528	20	CLAN	12
24529	25	CLAN	12
24530	30	CLAN	12
24531	40	CLAN	6
24532	50	CLAN	6
24533	60	CLAN	6

Candado clásico, latón, arco corto. Llaves iguales G.1

Código	Medida	Referencia		G1
24534	15	CLAN-IG1	12	
24535	20	CLAN-IG1	12	
24536	25	CLAN-IG1	12	
24537	30	CLAN-IG1	12	
24538	40	CLAN-IG1	6	
24539	50	CLAN-IG1	6	
24540	60	CLAN-IG1	6	

Candado clásico, latón, arco corto. Llaves iguales G.2

Código	Medida	Referencia		G2
24541	15	CLAN-IG2	12	
24542	20	CLAN-IG2	12	
24543	25	CLAN-IG2	12	
24544	30	CLAN-IG2	12	
24545	40	CLAN-IG2	6	
24546	50	CLAN-IG2	6	
24547	60	CLAN-IG2	6	

Candado clásico, latón, arco corto. Llaves iguales G.3

Código	Medida	Referencia		G3
24548	15	CLAN-IG3	12	
24549	20	CLAN-IG3	12	
24550	25	CLAN-IG3	12	
24551	30	CLAN-IG3	12	
24552	40	CLAN-IG3	6	
24553	50	CLAN-IG3	6	
24554	60	CLAN-IG3	6	

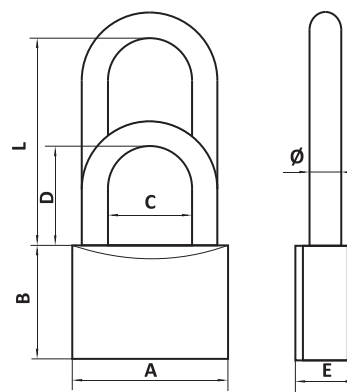

MEDIDA	A	B	C	D	E	L	Ø
15mm	17,2	18	8,8	12	9,5	-	3
20mm	20,5	20	10	12	10	23,5	3,5
25mm	25,5	25	13,5	16	11,8	25	4,2
30mm	30	28	16	17	13	32	5,1
40mm	40	33,6	22	24	14,5	41,5	6,3
50mm	50	40,5	27,5	30	16,8	49	8
60mm	60	42,5	31,5	37,5	18,5	58,5	9,5
70mm	70	48	40	41	20	-	11

Candado clásico, latón, arco largo. 2 llaves

Código	Medida	Referencia	
24555	20	CLAL	12
24556	25	CLAL	12
24557	30	CLAL	12
24558	40	CLAL	6
24559	50	CLAL	6

Candado clásico, latón, arco largo. Llaves iguales G1

Código	Medida	Referencia		G1
24560	20	CLAL-IG1	12	
24561	25	CLAL-IG1	12	
24562	30	CLAL-IG1	12	
24563	40	CLAL-IG1	6	
24564	50	CLAL-IG1	6	

Candado clásico, latón, arco largo. Llaves iguales G2

Código	Medida	Referencia		G2
24565	20	CLAL-IG2	12	
24566	25	CLAL-IG2	12	
24567	30	CLAL-IG2	12	
24568	40	CLAL-IG2	6	
24569	50	CLAL-IG2	6	

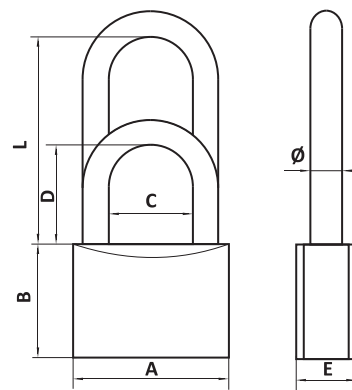

Candado clásico, latón, arco largo. Llaves iguales G3

Código	Medida	Referencia		G3
24570	20	CLAL-IG3	12	
24571	25	CLAL-IG3	12	
24572	30	CLAL-IG3	12	
24573	40	CLAL-IG3	6	
24574	50	CLAL-IG3	6	

Candado clásico, latón, arco corto. 2 llaves. Blíster

Código	Medida	Referencia	
24575	15	CLAN-B	12
24576	20	CLAN-B	12
24577	25	CLAN-B	12
24578	30	CLAN-B	12
24579	40	CLAN-B	6
24580	50	CLAN-B	6
24581	60	CLAN-B	6

Candado clásico, latón, arco largo. 2 llaves. Blíster

Código	Medida	Referencia	
24582	20	CLAL-B	12
24583	25	CLAL-B	12
24584	30	CLAL-B	12
24585	40	CLAL-B	6
24586	50	CLAL-B	6

Candados de latón arco cuadrado

- Cuerpo macizo de latón barnizado extrafuerte.
- Barra tratada.
- Cierre especial bola de acero.
- Cerradura de seguridad.
- Tres llaves de latón niqueladas.



Candado latón, arco cuadrado

Código	Medida	Referencia	
27579	60	CLC/60	6
27578	70	CLC/70	6
27289	90	CLC/90	6

A	B	C	D	E	F
60	42	16	20	14	9
70	47	17	24	16	10
90	57	19	32	20	12

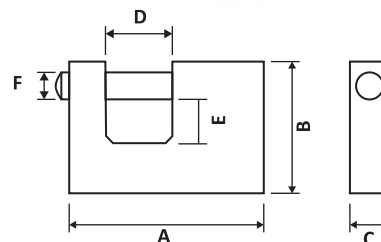

Pestillo clásico

- Acabado niquelado.
- De sobreponer.
- Varias medidas.

Pestillo clásico, niquelado

Código	Medida	Referencia	
23664	100mm	PES100	12
23665	85mm	PES85	12
23666	70mm	PES70	12
23667	60mm	PES60	12
23668	50mm	PES50	12
23669	40mm	PES40	12
23670	35mm	PES35	12
23671	30mm	PES30	12



FERRETERÍA Y HOGAR

Los mejores complementos para tus trabajos y para el hogar. Carretillas, escaleras, material eléctrico y burletes son algunos de los artículos que podrás encontrar en las siguientes páginas. Todo, con la garantía de Ferrotech



Elevación y utillaje **226**

Carretillas	226
Escaleras de aluminio	228

Material eléctrico **232**

Enrollacables	232
Alargaderas, regletas y extensibles	233
Conexiones eléctricas	234

Artículos para el hogar **235**

Aislamiento puertas y ventanas	235
Utensilios de corte	236



Elevación y utillaje

Carretillas

Carretilla de almacén

- Carretillas de hierro, con pala de 500x250 milímetros.
- Peso máximo de carga: 300 kilos.
- Posibilidad con ruedas macizas, neumáticas o impinchables.

Carretilla para almacén

Código	Rueda	Referencia	
21037	Maciza 2.00x4	CAR300-3	12
21038	Neumática 3.00x4	CAR300-3	12
21041	Impinchable 3.00x4	CAR300-3	12



Peso max.
300Kg.



Medida pala
500x250



Rueda maciza
cod. 21037



Rueda neumática
cod. 21038



Rueda impinchable
cod. 21041



Medida
115x50cm

Ruedas para carretilla de almacén

- Diferentes tipos de rueda para carretilla de almacén (neumática, maciza e impinchable).

Rueda neumática para carretilla de almacén

Código	Medida	Referencia	
23826	3.00x4	RP/CA	1



Peso max.
80Kg.



Rueda
neumática



Rueda maciza para carretilla de almacén

Código	Medida	Referencia	
23827	2.00/5.0/1.00	RP/CA-M	1



Peso max.
200Kg.



Rueda
maciza



Rueda impinchable para carretilla de almacén

Código	Medida	Referencia	
26378	3.00/4	RIP/CA-M	12



Peso max.
300Kg.



Rueda
impinchable



Carretilla plegable

- De aluminio, ideal para el transporte de objetos ligeros. Peso máximo: 70 kilos.
- Muy práctica por sus reducidas dimensiones por plegarse también las ruedas.

Carretilla plegable de aluminio

Código	Medida pala	Referencia	
20067	385x280mm	CAR70	1



Calidad
comprobada



Peso max.
70Kg.



Medida pala
385x280



Medida plegada
41x39x100cm



Medida plegada
60x39x64cm

Escaleras de aluminio

Escaleras y taburetes

- Máxima resistencia y fácil transporte. Calidad comprobada.
- Soporta 150 kilos como máximo.

Escalera soldada con barandilla y peldaño ancho 120mm antideslizante

Código	Medida	Peldaños	Referencia	
96515	111cm	5	ESC-A-5	1
96516	134cm	6	ESC-A-6	1
96517	157cm	7	ESC-A-7	1
96518	180cm	8	ESC-A-8	1
96519	203cm	9	ESC-A-9	1

- Medida: altura de trabajo.



Calidad comprobada



Fabricado en Europa



Peso máximo

Sección 40x20mm

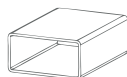

Frente 61x20mm

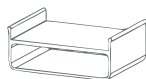

120mm



Escalera multiposición profesional

Código	Medida	Peldaños	Referencia	
26397	2,34m	4x4	ESC-M-4	1
27889	4,83m	4x5	ESC-M-5	1

- Medida: altura de trabajo.



Calidad comprobada



Fabricado en Europa



Peso máximo

Sección 66x25mm

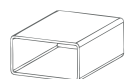

Peldaño 28x28mm



Apertura 180° y 30°

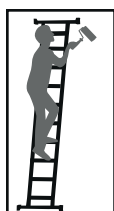

Escalera industrial

Código	Medida	Peldaños	Referencia		
96386	2,00m	7	ESC-1T7	1	SIMPLE
96387	2,50m	9	ESC-1T9	1	
96388	3,00m	11	ESC-1T11	1	
96389	3,50m	13	ESC-1T13	1	
96390	2,50m	9	ESC-2T-9	1	DOBLE
96391	3,00m	11	ESC-2T11	1	
96392	3,50m	13	ESC-2T13	1	
96393	6,00m	9	ESC-3T-9	1	TRIPLE
96394	7,50m	11	ESC-3T11	1	
96395*	9,00m	13	ESC-3T13	1	

Peldaño
28x28mm



Sección
65x25mm

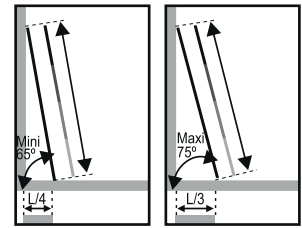

Grado de inclinación en uso 65°-75°

• Medida: altura de trabajo.

* Sin certificado EN131



Calidad comprobada



Fabricado en Europa



Peso máximo

SIMPLE



DOBLE



TRIPLE



Escalera aluminio doméstica

- Le permite realizar cualquier tarea de casa.
- Varias medidas y número de peldaños.
- Soporta un peso máximo de 150 kilos.

Escalera doméstica con barandilla

Código	Medida	Peldaños	Referencia	
96380	62cm	3	ESC-D-3	1
96381	86cm	4	ESC-D-4	1
96382	113cm	5	ESC-D-5	1
96383	134cm	6	ESC-D-6	1
96384	157cm	7	ESC-D-7	1
96385	179cm	8	ESC-D-8	1

- Medida: altura de trabajo.



Calidad comprobada



Fabricado en Europa



Peso máximo



Uso doméstico



Sección 33x20mm

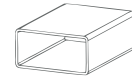

Frente 50x20mm

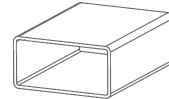

80mm

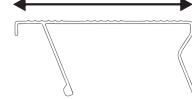

Taburete de aluminio

Código	Medida	Peldaños	Referencia	
96396	67cm	3	TAB-3	1

- Medida: altura de trabajo.



Calidad comprobada



Fabricado en Europa



Peso máximo



Uso doméstico



Sección 33x20mm

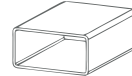

Frente 50x20mm

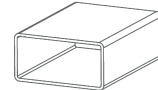

80mm

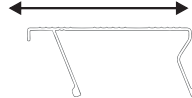

Escalera para hogar 2-3 peldaños

• Escaleras plegables de uso domestico, ideales para alcanzar esas zonas complicadas de la casa. Al ser plegables, podemos guardarlas con facilidad en cualquier lado, ya que no ocupan casi espacio. Disponible con 2 y 3 peldaños.

Escalera con barandilla. Blanco

Código	Medida	Peldaños	Referencia	
27888	116x47x15cm	2	ESC2-B150	1
27889	140x47x15cm	3	ESC3-B150	1



Calidad comprobada



Peso máximo



Peldaño 31x25cm



Uso doméstico



Goma antideslizante



Botón de seguridad





Material eléctrico

Enrollables

Enrollables

- Con protección 3G, en varias medidas. Calidad comprobada.
- Cuentan con tapas de protección.
- Nivel de protección: IP44 o IP55.

Enrollables con protección 3G 1,5mm

Código	Medida	Referencia	
21940	25m	N3G25	5
21941	50m	N3G50	5



Calidad comprobada



Certificado marcate CE



Certificado de calidad





Nivel protección



Tapas de protección

POTENCIA MÁXIMA

-  ENROLLADO
1.000 W. a 250 V
-  DESENRROLLADO
3.000 W. a 250 V

Enrollables con protección 3G 2,5mm

Código	Medida	Referencia	
27899	25m	3N3G25	5



Calidad comprobada



Certificado marcate CE



Certificado de calidad





Nivel protección



Tapas de protección

POTENCIA MÁXIMA

-  ENROLLADO
1.300 W. a 230 V
-  DESENRROLLADO
3.600 W. a 230 V

Alargaderas y regletas

- Ideal para llevar la corriente a lugares alejados o enchufar más de un aparato.
- Cuentan con protección infantil y certificado de calida.

Alargadera enchufe 5 metros

Código	Medida	Referencia	
25293	3G1.0,1.5mm2	AL-5M	10



Calidad comprobada



Certificado marcaje CE



Certificado de calidad



Protección infantil

Regleta enchufes con interruptor. Cable 1,5mm

Código	Medida	Referencia	Enchufes	
25194	3G1.5mm2	RI-3/1.5mm2	3	12
25195	3G1.5mm2	RI-4/1.5mm2	4	12
25196	3G1.5mm2	RI-5/1.5mm2	5	12
25197	3G1.5mm2	RI-6/1.5mm2	6	12



Calidad comprobada



Certificado marcaje CE



Certificado de calidad



Protección infantil



Uso doméstico

Extensible de hogar

- Alargadera para el hogar o uno para bricolaje con termostato.
- Cuentan con protección infantil y certificado de calida.

Extensible para hogar-bricolaje con termostato 3G1.5mm

Código	Medida	Referencia	
20508	10m	N3G-1x10	10
20509	15m	N3G-1x15	10



Calidad comprobada



Certificado marcaje CE



Certificado de calidad



Protección infantil





Uso doméstico

Alargaderas, regletas y extensibles



Termostato

POTENCIA MÁXIMA

-  ENROLLADO
1.000 W. a 230 V
-  DESENLROLLADO
3.000 W. a 230 V

Conexiones eléctricas

Regleta de conexión

- Para conexiones y derivaciones de instalaciones eléctricas.
- Se pueden cortar y existen en distinto diámetro medido en mm para meter un mayor o menor número de cables o cables de mayor diámetro.

PACK
10
udes



Regleta de conexiones

Código	Medida	Referencia	
27516	6A-6mm	RC-ELEC6A	100
27517	10A-10mm	RC-ELEC10A	50
27518	30A-16mm	RC-ELEC30A	30
27519	60A-25mm	RC-ELEC60A	20



Calidad comprobada



Certificado marcaje CE



Certificado de calidad

Terminales eléctricos

- Los terminales de cable están hechos de hierro metálico y aislante de PVC, el PVC puede proteger el haz de cables, son impermeables y anticongelantes y el hierro metálico tiene una excelente conductividad eléctrica.

Set de terminales eléctricos. 300 pzas.

Código	Referencia	
27515	SET-TR/ELC300	40

SET
300
PZAS



Calidad comprobada



Certificado marcaje CE



Certificado de calidad



RV1.25-3 25 udes.	RVS1.25-4 25 udes.	RV1.25-5 25 udes.	RV2-3 15 udes.	RVS2-4 20 udes.	RVL2-5 10 udes.
RV5.5-5 5 udes.	RV5.5-6 5 udes.	SV1.25-3 20 udes.	SV1.25-4 20 udes.	SVL2-4 20 udes.	BV1.25 10 udes.
BV2 10 udes.	BV5.5 10 udes.	MDD1.25-250 20 udes.	MDD2-250 20 udes.	FDD1.25-250 20 udes.	FDD2-250 20 udes.



Artículos para el hogar

Burletes adhesivos

• Burlete de caucho EPDM autoadhesivo para puertas y ventanas. Alta resistencia a la intemperie, fácil de instalar y de quitar, reduce la entrada de corrientes de aire, polvo, ruido, insectos... Favorece el ahorro energético, tanto en invierno como en verano.



Burlete aislante puerta-ventana caucho (EPDM). Rollo 6m

Código	Medida	Acabado	Referencia		Tipo
27728	9x6mm	Blanco	BUR-D9x6	60	
27729	9x6mm	Marrón	BUR-D9x6	60	
27730	9x4mm	Blanco	BUR-E9x4	60	
27731	9x4mm	Marrón	BUR-E9x4	60	

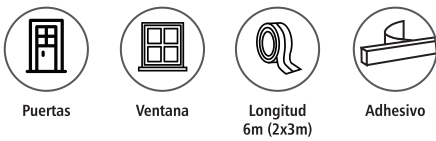

Aislamiento puertas y ventanas

Burletes bajo puerta

• Burlete fabricado en PVC para bajo de puertas. Evita la entrada de insectos, corrientes de aire, polvo, suciedad y reduce el impacto del ruido exterior. Aumenta el ahorro de energía, manteniendo la temperatura de la estancia por más tiempo. Disponible con escobilla de goma o cepillo.



Burlete bajo puerta PVC. Escobilla cepillo

Código	Medida	Acabado	Referencia	
27732	1000x42mm	Blanco	BUR-BP1m	1
27733	1000x42mm	Marrón	BUR-BP1m	1
27734	1000x42mm	Transparente	BUR-BP1m	1



Escobilla cepillo

Burlete bajo puerta PVC. Escobilla goma

Código	Medida	Acabado	Referencia	
27735	1000x42mm	Blanco	BUR-BP1m	1
27736	1000x42mm	Marrón	BUR-BP1m	1
27737	1000x42mm	Transparente	BUR-BP1m	1



Escobilla goma



Longitud 1m



Opción de corte a medida



Adhesivo

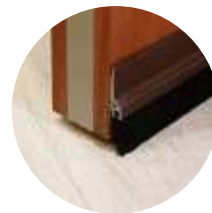
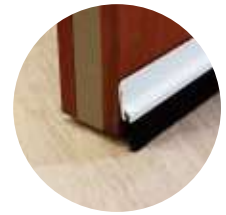

Utensilios de corte

Afilador de cuchillos con ventosa

Código	Acabado	Referencia	
26528	Rojo-negro	AF-1	12

Afilador de cuchillos

• Afilador de cuchillos, incluso de sierra, de forma segura y manos libres. Con ventosa para fijación en cualquier superficie lisa, plana y no porosa.



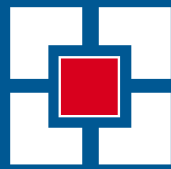

Ferrotech[®]

